



ADA Checklist for Existing Facilities

Based on the 2010 ADA Standards for Accessible Design



Produced by
Institute for Human Centered Design
www.HumanCenteredDesign.org

www.ADAchecklist.org
2014



ADA National Network
www.ADAta.org

Questions on the ADA 800-949-4232 voice/tty
Questions on checklist 617-695-0085 voice/tty
ADAinfo@NewEnglandADA.org



ADA Checklist for Existing Facilities

This checklist was produced by the New England ADA Center, a project of the Institute for Human Centered Design and a member of the ADA National Network. This checklist was developed under a grant from the Department of Education, NIDRR grant number H133A060092-09A. However the contents do not necessarily represent the policy of the Department of Education, and you should not assume endorsement by the Federal Government.

Questions or comments on the checklist contact the New England ADA Center at 617-695-0085 voice/tty or ADAinfo@NewEnglandADA.org

For the full set of checklists, including the checklists for recreation facilities visit www.ADAchecklist.org.

ADA Checklist for Existing Facilities

The Americans with Disabilities Act (ADA) requires state and local governments, businesses and non-profit organizations to provide goods, services and programs to people with disabilities on an equal basis with the rest of the public.

Some people think that only new construction and alterations need to be accessible and that older facilities are “grandfathered,” but that’s not true. Because the ADA is a civil rights law and not a building code, older facilities are often required to be accessible to ensure that people with disabilities have an equal opportunity to participate.

The ADA has different requirements for state and local governments and for places of public accommodation (businesses and non-profit organizations that serve the public).

Requirements for State and Local Governments

State and local governments must ensure that services, programs and activities, when viewed in their entirety, are accessible to people with disabilities. This is part of public entities’ program accessibility obligations. Alterations to older buildings may be needed to ensure program accessibility. Generally this is a greater obligation than “readily achievable barrier removal” the standard that applies to public accommodations. State and local governments are not required to take any action that would result in undue financial and administrative burdens.

State and local governments’ ADA obligations for program accessibility are in the Department of Justice’s ADA Title II regulations 28 CFR Part 35.150.

How to Use this Checklist

Get Organized

One person can conduct a survey, but it’s easier with two people. One person can take measurements and the other person can fill out the checklist and take photos.

Obtain Floor Plan or Make Sketch

A floor plan helps the surveyors to get organized and to know how many elements there are, such as entrances and toilet rooms. If plans are not available, sketch the exterior and interior layout of interior and exterior spaces and mark the elements on the sketch.

Make Copies of the Checklist

Determine how many copies of each section of the checklist you need. For example, most facilities have more than one toilet room.

Gather Tools

- Checklist
- Clipboard
- Tape measure
- Electronic or carpenter’s level - 24 inches
- Door pressure gauge or fish scale
- Camera
- Bag to hold these items

Requirements for Places of Public Accommodation

Businesses and non-profit organizations that serve the public must remove architectural barriers when it is “readily achievable” to do so; in other words, when barrier removal is “easily accomplishable and able to be carried out without much difficulty or expense.”

The decision of what is readily achievable is made considering the size, type, and overall finances of the public accommodation and the nature and cost of the access improvements needed. Barrier removal that is difficult now may be readily achievable in the future as finances change.

Public accommodations’ ADA obligations for barrier removal are in the Department of Justice’s ADA Title III regulations 28 CFR Part 36.304.

Priorities for Accessibility

The checklist follows the four priorities that are listed in the Department of Justice ADA Title III regulations. These priorities are equally applicable to state and local government facilities.

Priority 1 - Accessible approach and entrance

Priority 2 - Access to goods and services

Priority 3 - Access to public toilet rooms

Priority 4 - Access to other items such as water fountains and public telephones

Conduct the Survey

Start Outside

Start from site arrival points such as drop-off areas and sidewalks. Determine if there is an accessible route to an accessible entrance. If there is a parking lot or garage check for the correct number of accessible parking spaces, including van-accessible spaces. Is there an accessible route from the accessible parking spaces to an accessible entrance? Next survey the entrances. If there is an accessible entrance, determine if there are signs at inaccessible entrances directing people to the accessible entrance. Go inside and continue through the facility.

Keep Good Notes

Write on the front of each checklist where you are surveying. You may end up with six toilet room checklists. When you get back to your office you’ll want to know which one is the checklist for the first floor women’s room. If there isn’t an accessible entrance you’ll want to indicate how many steps there are and how much space is available to install a ramp or lift. This is a good time to take photographs.

Take Good Measurements

When in doubt write it down. It’s better to have too much information than not enough. Even if something is in compliance it’s helpful to have exact measurements.

2010 ADA Standards for Accessible Design

The checklist is based on the 2010 ADA Standards for Accessible Design (2010 Standards). The checklist does not include all sections of the 2010 Standards. For example there are no questions about patient rooms in hospitals or guest rooms in hotels. Consult the 2010 Standards for situations not covered in the checklist. Full compliance with the 2010 Standards is required only for new construction and alterations.

Safe Harbor – Construction Prior to March 15, 2012

Elements in facilities built or altered before March 15, 2012 that comply with the 1991 ADA Standards for Accessible Design (1991 Standards) are not required to be modified to specifications in the 2010 Standards. For example, the 1991 Standards allow 54 inches maximum for a side reach range to a control such as the operating part of a paper towel dispenser. The 2010 Standards lower that side reach range to 48 inches maximum. If a paper towel dispenser was installed prior to March 15, 2012 with the highest operating part at 54 inches, the paper towel dispenser does not need to be lowered to 48 inches.

Elements in the 2010 Standards that aren't in the 1991 Standards

The 2010 Standards contain elements that are not in the 1991 Standards. These elements include recreation facilities such as swimming pools, team and player seating, accessible routes to court sports facilities, saunas and steam rooms, fishing piers, play areas, exercise machines, golf facilities, miniature golf facilities, amusement rides, shooting facilities with firing positions, and recreational boating facilities. Because these elements are not in the 1991 Standards, they are not subject to the safe harbor exemption. State and local governments must make these items

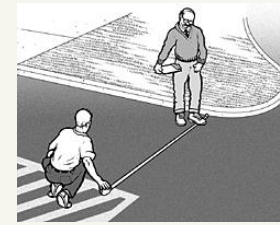

Parking Spaces

Measure from the center of marking lines. If lines are not adjacent to another space or aisle the measurement can be to the full width of the line.



Door Clear Width

Open the door 90 degrees, measure from the face of the door to the edge of the door stop.

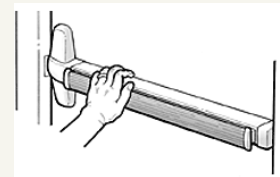

Door Opening Force

Place the door pressure gauge where you would push open the door.

If you're using a fish scale, place it where you would pull open the door.

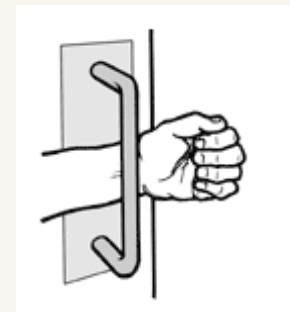

accessible if necessary to ensure program accessibility, unless an undue burden would result. Public accommodations must remove architectural barriers to these items.

What this Checklist is Not

The ADA Title II and III regulations require more than program accessibility and barrier removal. The regulations include requirements for nondiscriminatory policies and practices and for the provision of auxiliary aids and services, such as sign language interpreters for people who are deaf and material in Braille for people who are blind. This checklist does not cover those requirements.

Since this checklist does not include all of the 2010 Standards it is not intended to determine compliance for new construction or facilities being altered.

What are Public Accommodations?

Under the ADA public accommodations are private entities that own, lease, lease to or operate a place of public accommodation. This means that both a landlord who leases space in a building to a tenant and the tenant who operates a place of public accommodation have responsibilities to remove barriers.

A place of public accommodation is a facility whose operations affect commerce and fall within at least one of the following 12 categories:

- 1) Places of lodging (e.g., inns, hotels, motels, except for owner-occupied establishments renting fewer than six rooms)
- 2) Establishments serving food or drink (e.g. , restaurants and bars)
- 3) Places of exhibition or entertainment (e.g. , motion picture houses, theaters, concert



Accessible Slopes

You can measure slope with a 24 inch level and a tape measure. Put the level on the surface in the direction you are

measuring. Put one end at the high point of the surface and raise the other end so that the bubble is in the middle of the level's gauge. The level is now level. Measure the distance between the end of the level at its bottom point and the surface.

For a ramp the maximum running slope allowed is 1:12. That means for every inch of height change there should be at least 12 inches of ramp run. If the distance between the bottom of the level and the ramp surface is 2 inches or less, then the slope is 1:12 or less ($2:24 = 1:12$ and $1.5:24 = 1:16$ which is a more gradual slope than 1:12). If the distance is greater than 2 inches, the ramp is too steep. For example, if the distance is 3 inches, then the slope is 1:8 ($3:24 = 1:8$ which is a steeper slope than 1:12).

For the parts of an accessible route that aren't a ramp, the maximum running slope allowed is 1:20. That means for every inch of height change there must be at least 20 inches of route run. The distance from the bottom edge of the level to the surface should be no more than 1.2 inches ($1.2:24 = 1:20$).

- halls, stadiums)
- 4) Places of public gathering (e.g. , auditoriums, convention centers, lecture halls)
 - 5) Sales or rental establishments (e.g. , bakeries, grocery stores, hardware stores, shopping centers)
 - 6) Service establishments (e.g. , laundromats, dry-cleaners, banks, barber shops, beauty shops, travel services, shoe repair services, funeral parlors, gas stations, offices of accountants or lawyers, pharmacies, insurance offices, professional offices of health care providers, hospitals)
 - 7) Public transportation terminals, depots, or stations (not including facilities relating to air transportation)
 - 8) Places of public display or collection (e.g. , museums, libraries, galleries)
 - 9) Places of recreation (e.g. , parks, zoos, amusement parks)
 - 10) Places of education (e.g. , nursery schools, elementary, secondary, undergraduate, or postgraduate private schools)
 - 11) Social service center establishments (e.g. , day care centers, senior citizen centers, homeless shelters, food banks, adoption agencies)
 - 12) Places of exercise or recreation (e.g. , gymnasiums, health spas, bowling alleys, golf courses).

For the cross slope of an accessible route the maximum slope allowed is 1:48. The distance from the bottom edge of the level to the surface should be no more than ½ inch (.5:24 = 1:48). The cross slope of an accessible route is the slope that is perpendicular to the direction of pedestrian travel.

Slopes may also be measured using a digital level. Be sure to read the instructions. Measure with the percent calculation rather than the degrees calculation. For a ramp the maximum running slope allowed is 8.33% (8.33% is a 1:12 slope). For an accessible route without a ramp the maximum running slope allowed is 5% (1:20). For the cross slope of an accessible route the maximum slope allowed is 2.083% (1:48).

Check that You Got Everything - Before you leave the site review all the checklists. Make sure you know which checklist goes with which entrance and which toilet room and that you've got all the information you need. It is better to do it now than to have to go back.

After the Survey

List Barriers and Solutions - Consider the solutions listed beside each question on the checklist and add your own ideas. Consult with building contractors and equipment suppliers to estimate the costs for making modifications.

Resources

U.S. Department of Justice ADA Information

800-514-0301 voice
800-514-0383 TTY
www.ada.gov

ADA National Network

800-949-4232 voice/TTY connects to your regional ADA Center
www.adata.org

U.S. Access Board

800- 872-2253 voice
800-993-2822 TTY
www.access-board.gov

ADA Title III Regulations 28 CFR Part 36

www.ada.gov/regs2010/titleIII_2010/titleIII_2010_regulations.htm

2010 ADA Standards for Accessible Design

www.ada.gov/2010ADAstandards_index.htm

1991 ADA Standards for Accessible Design

www.ada.gov/stdspdf.htm

Tax Deductions and Credits for Barrier Removal

www.ada.gov/taxincent.htm

Acknowledgements

Many of the illustrations are from the U.S. Department of Justice and the U.S. Access Board or are based on illustrations produced by the U.S. Access Board and the U.S. Department of Justice.

Develop a Plan – State and local governments were required to develop a Transition Plan a few years after the ADA went into effect. Conducting a current survey is a good opportunity to update the plan.

Although places of public accommodation are not required to have a plan,, the Department of Justice recommends one: *"...Such a plan...could serve as evidence of a good faith effort to comply..."*

Prioritize items, make a timeline, decide who is responsible to carry out the plan and develop a budget.

Make Changes - Use the 2010 ADA Standards for Accessible Design. Check whether local and state building codes require greater accessibility when alterations are undertaken.

Follow Up - Review the plan each year to evaluate whether more access improvements can be made.

ADA Checklist for Existing Facilities

Priority 1 – Approach & Entrance

Based on the 2010 ADA Standards for Accessible Design



Project _____

Building _____

Location _____

Date _____

Surveyors _____

Contact Information _____

An accessible route from site arrival points and an accessible entrance should be provided for everyone.



Institute for Human Centered Design
www.HumanCenteredDesign.org

2014



ADA National Network
Questions on the ADA 800-949-4232 voice/tty
www.ADAchecklist.org

This checklist was produced by the New England ADA Center, a project of the Institute for Human Centered Design and a member of the ADA National Network. This checklist was developed under a grant from the Department of Education, NIDRR grant number H133A060092-09A. However the contents do not necessarily represent the policy of the Department of Education, and you should not assume endorsement by the Federal Government.



Questions or comments on the checklist contact the New England ADA Center at 617-695-0085 voice/tty or ADAinfo@NewEnglandADA.org

For the full set of checklists, including the checklists for recreation facilities visit www.ADAchecklist.org.

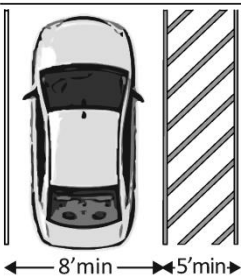
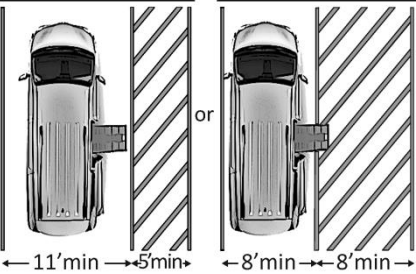
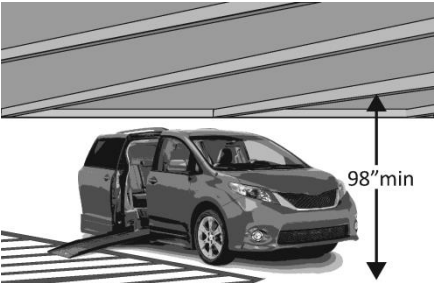
Priority 1 – Approach & Entrance			Comments	Possible Solutions												
<p>1.1 Is there at least one route from site arrival points (parking, passenger loading zones, public sidewalks and public transportation stops) that does not require the use of stairs? [See 2010 ADA Standards for Accessible Design – 206.2.1]</p>	<p><input type="checkbox"/> Yes <input type="checkbox"/> No</p> <p>If yes, location of route:</p>		<p>Photo #:</p>	<ul style="list-style-type: none"> • Add a ramp • Regrade to 1:20 maximum slope • Add a lift if site constraints prevent other solutions 												
<p>Parking Accessible parking spaces should be identified by size, access aisle and signage.</p>																
<p>1.2 If parking is provided for the public, are an adequate number of accessible spaces provided? [208.2]</p>	<p><input type="checkbox"/> Yes <input type="checkbox"/> No</p> <p>Total #:</p> <p>Accessible #:</p>	<table border="1"> <thead> <tr> <th>Total Spaces</th> <th>Accessible Spaces</th> </tr> </thead> <tbody> <tr> <td>1 - 25</td> <td>1</td> </tr> <tr> <td>26 - 50</td> <td>2</td> </tr> <tr> <td>51 - 75</td> <td>3</td> </tr> <tr> <td>76 - 100</td> <td>4</td> </tr> <tr> <td colspan="2">100+ see 2010 Standards 208.2</td> </tr> </tbody> </table>	Total Spaces	Accessible Spaces	1 - 25	1	26 - 50	2	51 - 75	3	76 - 100	4	100+ see 2010 Standards 208.2		<p>Photo #:</p>	<ul style="list-style-type: none"> • Reconfigure by repainting lines • •
Total Spaces	Accessible Spaces															
1 - 25	1															
26 - 50	2															
51 - 75	3															
76 - 100	4															
100+ see 2010 Standards 208.2																
<p>1.3 Of the accessible spaces, is at least one a van accessible space?*[208.2.4]</p>	<p><input type="checkbox"/> Yes <input type="checkbox"/> No</p>	<p>*For every 6 or fraction of 6 parking spaces required by the table above, at least 1 should be a van accessible space.</p>	<p>Photo #:</p>	<ul style="list-style-type: none"> * If constructed before 3/15/2012, parking is compliant if at least 1 in every 8 accessible spaces is van accessible • Reconfigure by repainting lines 												

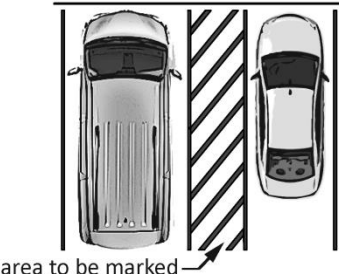
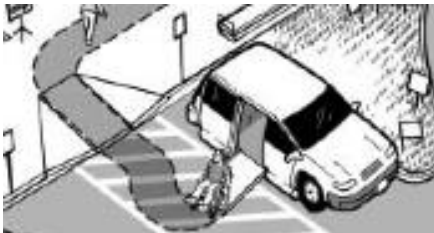
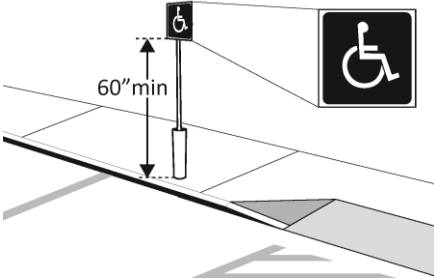
<p>1.4 Are accessible spaces at least 8 feet wide with an access aisle at least 5 feet wide? [502.2, 502.3]</p> <p>Note: Two spaces may share an access aisle. Check state/local requirements; some specify that each space have its own aisle.</p>	<p><input type="checkbox"/> Yes <input type="checkbox"/> No</p> <p>Measurement:</p>		<p>Photo #:</p>	<ul style="list-style-type: none"> • Reconfigure by repainting lines • •
<p>1.5 Is the van accessible space:</p> <p>At least 11 feet wide with an access aisle at least 5 feet wide? Or At least 8 feet wide with an access aisle at least 8 feet wide? [502.2]</p>	<p><input type="checkbox"/> Yes <input type="checkbox"/> No</p> <p>Measurement:</p> <p><input type="checkbox"/> Yes <input type="checkbox"/> No</p> <p>Measurement:</p>		<p>Photo #:</p>	<ul style="list-style-type: none"> • Reconfigure to provide van-accessible space(s) • •
<p>1.6 Is at least 98 inches of vertical clearance provided for the van accessible space? [502.5]</p>	<p><input type="checkbox"/> Yes <input type="checkbox"/> No</p> <p>Measurement:</p>		<p>Photo #:</p>	<ul style="list-style-type: none"> • Reconfigure to provide van-accessible space(s) • •

<p>1.7 Are the access aisles marked so as to discourage parking in them? [502.3.3]</p> <p>Note: The marking method and color may be addressed by state/local requirements.</p>	<p><input type="checkbox"/> Yes <input type="checkbox"/> No</p>		<p>Photo #:</p>	<ul style="list-style-type: none"> • Mark access aisles • •
<p>1.8 Is the slope of the accessible parking spaces and access aisles no steeper than 1:48 in all directions? [502.4]</p>	<p><input type="checkbox"/> Yes <input type="checkbox"/> No</p> <p>Measurement:</p>		<p>Photo #:</p>	<ul style="list-style-type: none"> • Regrade surface • •
<p>1.9 Do the access aisles adjoin an accessible route? [502.3]</p>	<p><input type="checkbox"/> Yes <input type="checkbox"/> No</p>		<p>Photo #:</p>	<ul style="list-style-type: none"> • Create accessible route • Relocate accessible space •
<p>1.10 Are accessible spaces identified with a sign that includes the International Symbol of Accessibility? Is the bottom of the sign at least 60 inches above the ground? [502.6]</p> <p>Note: The International Symbol of Accessibility is not required on the ground.</p>	<p><input type="checkbox"/> Yes <input type="checkbox"/> No</p> <p><input type="checkbox"/> Yes <input type="checkbox"/> No</p> <p>Measurement:</p>		<p>Photo #:</p>	<ul style="list-style-type: none"> • Install signs • •

<p>1.11 Are there signs reading “van accessible” at van accessible spaces? [502.6]</p>	<p><input type="checkbox"/> Yes <input type="checkbox"/> No</p>		<p>Photo #:</p>	<ul style="list-style-type: none"> • Install signs • •
<p>1.12 Of the total parking spaces, are the accessible spaces located on the closest accessible route to the accessible entrance(s)? [208.3.1]</p> <p>Note: If parking serves multiple entrances, accessible parking should be dispersed.</p>	<p><input type="checkbox"/> Yes <input type="checkbox"/> No</p>		<p>Photo #:</p>	<ul style="list-style-type: none"> • Reconfigure spaces • •
<p>Exterior Accessible Route</p>				
<p>1.13 Is the route stable, firm and slip-resistant? [302.1]</p>	<p><input type="checkbox"/> Yes <input type="checkbox"/> No</p>		<p>Photo #:</p>	<ul style="list-style-type: none"> • Repair uneven paving • Fill small bumps and breaks with patches • Replace gravel with asphalt or other surface
<p>1.14 Is the route at least 36 inches wide? [403.5.1]</p>	<p><input type="checkbox"/> Yes <input type="checkbox"/> No</p> <p>Measurement:</p>			<ul style="list-style-type: none"> • Change or move landscaping, furnishings or other items • Widen route •

<p>Note: The accessible route can narrow to 32 inches min. for a max. of 24 inches. These narrower portions of the route must be at least 48 inches from each other.</p>			<p>Photo #:</p>	
<p>1.15 If the route is greater than 200 feet in length and less than 60 inches wide, is there a passing space no less than 60 x 60 inches? [403.5.3]</p>	<p><input type="checkbox"/> Yes <input type="checkbox"/> No</p> <p>Measurement:</p>		<p>Photo #:</p>	<ul style="list-style-type: none"> • Widen route for passing space • •
<p>1.16 If there are grates or openings on the route, are the openings no larger than 1/2 inches? Is the long dimension perpendicular to the dominant direction of travel? [302.3]</p>	<p><input type="checkbox"/> Yes <input type="checkbox"/> No</p> <p>Measurement:</p> <p><input type="checkbox"/> Yes <input type="checkbox"/> No</p>		<p>Photo #:</p>	<ul style="list-style-type: none"> • Replace or move grate • •
<p>1.17 Is the running slope no steeper than 1:20, i.e. for every inch of height change there are at least 20 inches of route run? [403.3]</p> <p>Note: If the running slope is steeper than 1:20, treat as a ramp and add features such as edge protection and handrails.</p>	<p><input type="checkbox"/> Yes <input type="checkbox"/> No</p> <p>Measurement:</p>		<p>Photo #:</p>	<ul style="list-style-type: none"> • Regrade to 1:20 max. • •

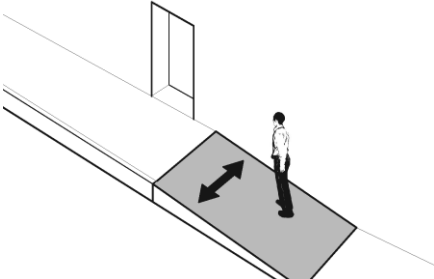
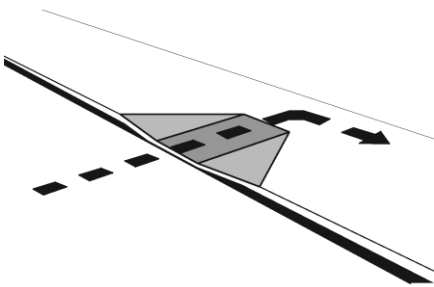
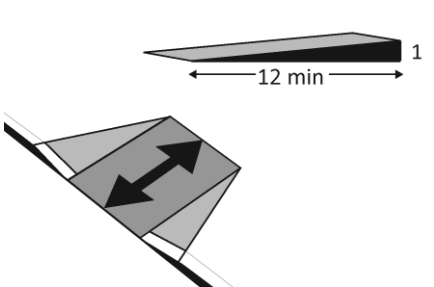
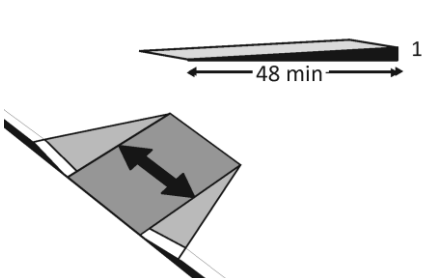
<p>1.18 Is the cross slope no steeper than 1:48? [403.3]</p>	<p><input type="checkbox"/> Yes <input type="checkbox"/> No</p> <p>Measurement:</p>		<p>Photo #:</p>	<ul style="list-style-type: none"> • Regrade to 1:48 max. • •
<p>Curb Ramps</p>				
<p>1.19 If the accessible route crosses a curb, is there a curb ramp? [402.2]</p>	<p><input type="checkbox"/> Yes <input type="checkbox"/> No</p>		<p>Photo #:</p>	<ul style="list-style-type: none"> • Install curb ramp • •
<p>1.20 Is the running slope of the curb ramp no steeper than 1:12, i.e. for every inch of height change there are at least 12 inches of curb ramp run? [406.1, 405.2]</p>	<p><input type="checkbox"/> Yes <input type="checkbox"/> No</p> <p>Measurement:</p>		<p>Photo #:</p>	<ul style="list-style-type: none"> • Regrade curb ramp • •
<p>1.21 Is the cross slope of the curb ramp, excluding flares, no steeper than 1:48? [406.1, 405.3]</p>	<p><input type="checkbox"/> Yes <input type="checkbox"/> No</p> <p>Measurement:</p>		<p>Photo #:</p>	<ul style="list-style-type: none"> • Regrade curb ramp • •

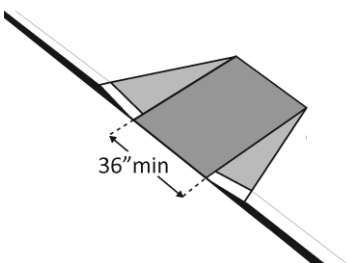
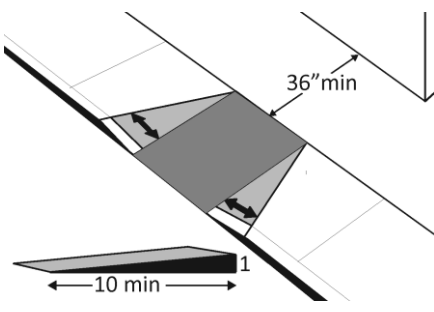
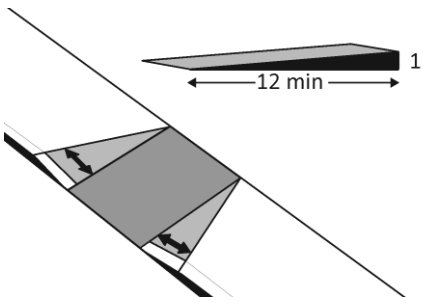

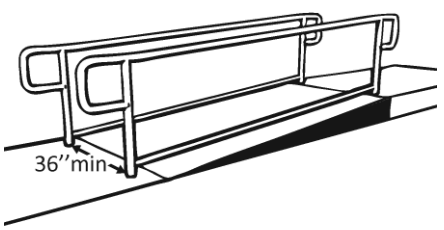
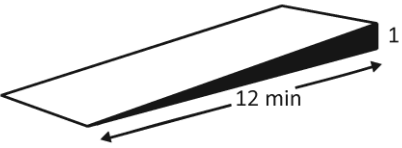
<p>1.22 Is the curb ramp, excluding flares, at least 36 inches wide? [406.1, 405.5]</p>	<p><input type="checkbox"/> Yes <input type="checkbox"/> No</p> <p>Measurement:</p>		<p>Photo #:</p>	<ul style="list-style-type: none"> • Widen curb ramp • •
<p>1.23 At the top of the curb ramp is there a level landing (slope no steeper than 1:48 in all directions) that is at least 36 inches long and at least as wide as the curb ramp? [406.4]</p> <p>If there are curb ramp flares, are the slopes of the flares no steeper than 1:10, i.e. for every inch of height change there are at least 10 inches of flare run? [406.3]</p>	<p><input type="checkbox"/> Yes <input type="checkbox"/> No</p> <p>Measurement:</p> <p><input type="checkbox"/> Yes <input type="checkbox"/> No</p> <p>Measurement:</p>		<p>Photo #:</p>	<ul style="list-style-type: none"> • Reconfigure • Add ramp flares •
<p>1.24 If the landing at the top is less than 36 inches long, are there curb ramp flares?</p> <p>Are the slopes of the flares no greater than 1:12, i.e. for every inch of height change there are at least 12 inches of flare run? [406.4]</p>	<p><input type="checkbox"/> Yes <input type="checkbox"/> No</p> <p><input type="checkbox"/> Yes <input type="checkbox"/> No</p> <p>Measurement:</p>		<p>Photo #:</p>	<ul style="list-style-type: none"> • Add ramp flares • Regrade flares •

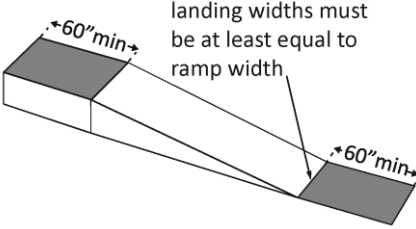
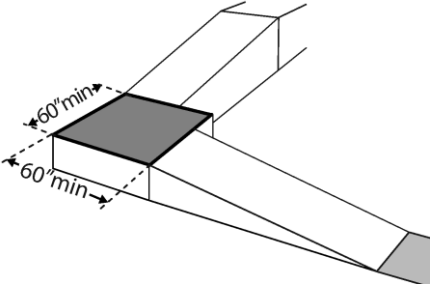
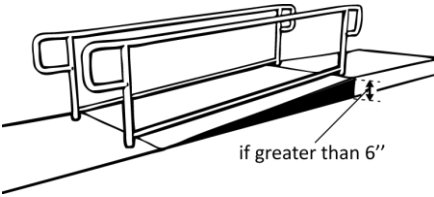
Ramps If any portion of the accessible route is steeper than 1:20, it should be treated as a ramp.				
<p>1.25 If there is a ramp is it at least 36 inches wide? [405.5]</p> <p>Note: If there are handrails, measure between the handrails.</p>	<p><input type="checkbox"/> Yes <input type="checkbox"/> No</p> <p>Measurement:</p>		<p>Photo #:</p>	<ul style="list-style-type: none"> • Alter ramp • •
<p>1.26 Is the surface stable, firm and slip resistant? [405.4]</p>	<p><input type="checkbox"/> Yes <input type="checkbox"/> No</p>		<p>Photo #:</p>	<ul style="list-style-type: none"> • Resurface ramp • •
<p>1.27 For each section of the ramp, is the running slope no greater than 1:12, i.e. for every inch of height change there are at least 12 inches of ramp run? [405.2]</p> <p>Note: Rises no greater than 3 inches with a slope no steeper than 1:8 and rises no greater than 6 inches with a slope no steeper than 1:10 are permitted when such slopes are necessary due to space limitations.</p>	<p><input type="checkbox"/> Yes <input type="checkbox"/> No</p> <p>Measurement:</p>		<p>Photo #:</p>	<ul style="list-style-type: none"> • Relocate ramp • Lengthen ramp to decrease slope •

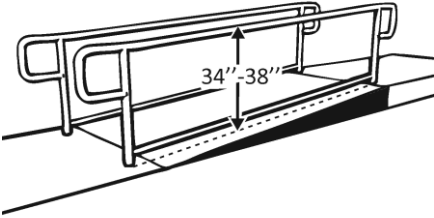
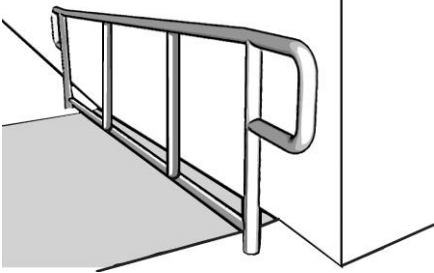
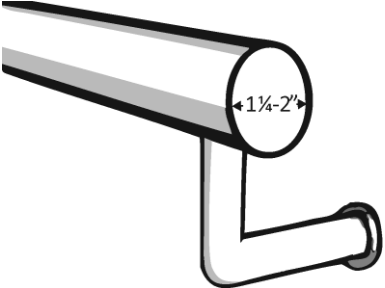
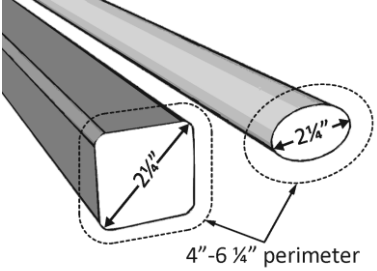
<p>1.28 Is there a level landing that is at least 60 inches long and at least as wide as the ramp:</p> <p>At the top of the ramp?</p> <p>At the bottom of the ramp? [405.7.2, 405.7.3]</p>	<p><input type="checkbox"/> Yes <input type="checkbox"/> No</p> <p>Measurement:</p> <p><input type="checkbox"/> Yes <input type="checkbox"/> No</p> <p>Measurement:</p>		<p>Photo #:</p>	<ul style="list-style-type: none"> • Alter ramp • Relocate ramp •
<p>1.29 Is there a level landing where the ramp changes direction that is at least 60 x 60 inches? [405.7.4]</p>	<p><input type="checkbox"/> Yes <input type="checkbox"/> No</p> <p>Measurement:</p>		<p>Photo #:</p>	<ul style="list-style-type: none"> • Alter ramp • Increase landing size •
<p>1.30 If the ramp has a rise higher than 6 inches, are there handrails on both sides? [405.8]</p> <p>Note: Curb ramps are not required to have handrails.</p>	<p><input type="checkbox"/> Yes <input type="checkbox"/> No</p> <p>Measurement:</p>		<p>Photo #:</p>	<ul style="list-style-type: none"> • Add handrails • •

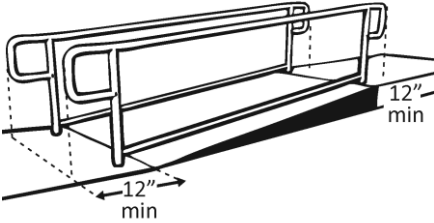
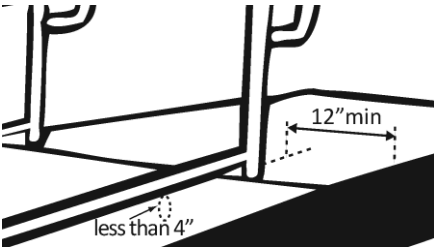
<p>1.31 Is the top of the handrail gripping surface no less than 34 inches and no greater than 38 inches above the ramp surface? [505.4]</p>	<p><input type="checkbox"/> Yes <input type="checkbox"/> No</p> <p>Measurement:</p>		<p>Photo #:</p>	<ul style="list-style-type: none"> • Reconfigure or replace handrails • Adjust handrail height •
<p>1.32 Is the handrail gripping surface continuous and not obstructed along the top or sides? [505.3]</p> <p>If there are obstructions, is the bottom of the gripping surface obstructed no greater than 20%? [505.6]</p>	<p><input type="checkbox"/> Yes <input type="checkbox"/> No</p> <p><input type="checkbox"/> Yes <input type="checkbox"/> No</p> <p>Measurement:</p>		<p>Photo #:</p>	<ul style="list-style-type: none"> • Reconfigure or replace handrails • •
<p>1.33 If the handrail gripping surface is circular, is it no less than 1 ¼ inches and no greater than 2 inches in diameter? [505.7.1]</p>	<p><input type="checkbox"/> Yes <input type="checkbox"/> No</p> <p>Measurement:</p>		<p>Photo #:</p>	<ul style="list-style-type: none"> • Replace handrails • •
<p>1.34 If the handrail gripping surface is non-circular:</p> <p>Is the perimeter no less than 4 inches and no greater than 6 ¼ inches?</p>	<p><input type="checkbox"/> Yes <input type="checkbox"/> No</p> <p>Measurement:</p> <p><input type="checkbox"/> Yes <input type="checkbox"/> No</p> <p>Measurement:</p>		<p>Photo #:</p>	<ul style="list-style-type: none"> • Replace handrails • •

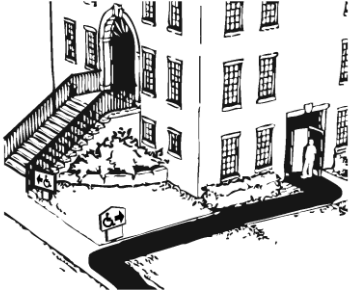
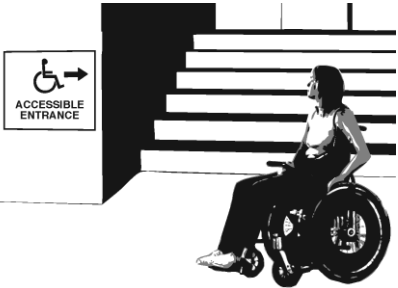

<p>Is the cross section no greater than 2¼ inches? [505.7.2]</p>	<p><input type="checkbox"/> Yes <input type="checkbox"/> No Measurement:</p>		<p>Photo #:</p>	
<p>1.35 Does the handrail:</p> <p>Extend at least 12 inches horizontally beyond the top and bottom of the ramp?</p> <p>Return to a wall, guard, or landing surface? [505.10.1]</p> <p>Note: If a 12 inch extension would be a hazard (in circulation path) it is not required.</p>	<p><input type="checkbox"/> Yes <input type="checkbox"/> No Measurement:</p> <p><input type="checkbox"/> Yes <input type="checkbox"/> No Measurement:</p>		<p>Photo #:</p>	<ul style="list-style-type: none"> • Alter handrails • •
<p>1.36 To prevent wheelchair casters and crutch tips from falling off:</p> <p>Does the surface of the ramp extend at least 12 inches beyond the inside face of the handrail? Or Is there a curb or barrier that prevents the passage of a 4-inch diameter sphere? [405.9.1, 405.9.2]</p>	<p><input type="checkbox"/> Yes <input type="checkbox"/> No Measurement:</p> <p><input type="checkbox"/> Yes <input type="checkbox"/> No Measurement:</p>		<p>Photo #:</p>	<ul style="list-style-type: none"> • Add curb • Add barrier • Extend ramp width •

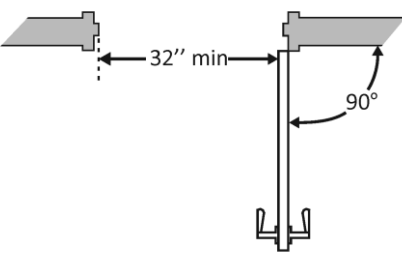
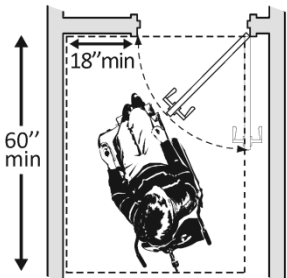
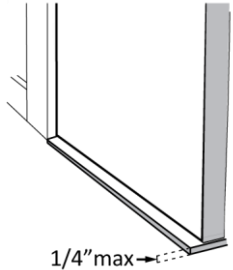
Entrance				
<p>1.37 Is the main entrance accessible?</p>	<p><input type="checkbox"/> Yes <input type="checkbox"/> No</p>		<p>Photo #:</p>	<ul style="list-style-type: none"> • Redesign to make it accessible • •
<p>1.38 If the main entrance is not accessible, is there an alternative accessible entrance?</p> <p>Can the alternative accessible entrance be used independently and during the same hours as the main entrance?</p>	<p><input type="checkbox"/> Yes <input type="checkbox"/> No</p> <p><input type="checkbox"/> Yes <input type="checkbox"/> No</p>		<p>Photo #:</p>	<ul style="list-style-type: none"> • Designate an entrance and make it accessible • Ensure that accessible entrance can be used independently and during the same hours as the main entrance •
<p>1.39 Do all inaccessible entrances have signs indicating the location of the nearest accessible entrance? [216.6]</p>	<p><input type="checkbox"/> Yes <input type="checkbox"/> No</p>		<p>Photo #:</p>	<ul style="list-style-type: none"> • Install signs • Install signs on route before people get to inaccessible entrances so that people do not have to turn around and retrace route •
<p>1.40 If not all entrances are accessible, is there a sign at the accessible entrance with the International Symbol of Accessibility? [216.6]</p>	<p><input type="checkbox"/> Yes <input type="checkbox"/> No</p>		<p>Photo #:</p>	<ul style="list-style-type: none"> • Install sign • •

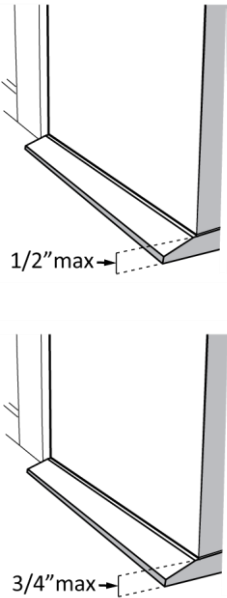
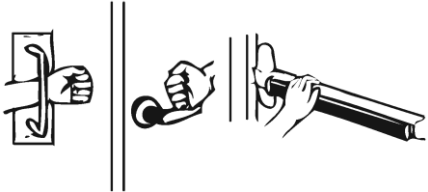
<p>1.41 Is the clear opening width of the accessible entrance door at least 32 inches, between the face of the door and the stop, when the door is open 90 degrees? [404.2.3]</p>	<p><input type="checkbox"/> Yes <input type="checkbox"/> No Measurement:</p>		<p>Photo #:</p>	<ul style="list-style-type: none"> • Alter door • Install offset hinges •
<p>1.42 If there is a front approach to the pull side of the door, is there at least 18 inches of maneuvering clearance beyond the latch side plus at least 60 inches clear depth? Note: See 2010 Standards 404.2.4 for maneuvering clearance requirements on the push side of the door and side approaches to the pull side of the door</p> <p>On both sides of the door, is the ground or floor surface of the maneuvering clearance level (no steeper than 1:48)? [404.2.4]</p>	<p><input type="checkbox"/> Yes <input type="checkbox"/> No Measurement:</p> <p><input type="checkbox"/> Yes <input type="checkbox"/> No Measurement:</p>		<p>Photo #:</p>	<ul style="list-style-type: none"> • Remove obstructions • Reconfigure walls • Add automatic door opener
<p>1.43 If the threshold is vertical is it no more than ¼ inch high? Or No more than ½ inch high with the top ¼ inch beveled no steeper than 1:2, if the threshold was installed on or</p>	<p><input type="checkbox"/> Yes <input type="checkbox"/> No Measurement:</p> <p><input type="checkbox"/> Yes <input type="checkbox"/> No Measurement:</p>		<p>Photo #:</p>	<ul style="list-style-type: none"> • Remove or replace threshold • •

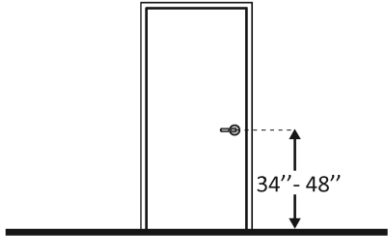
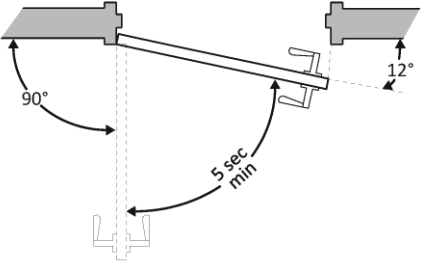
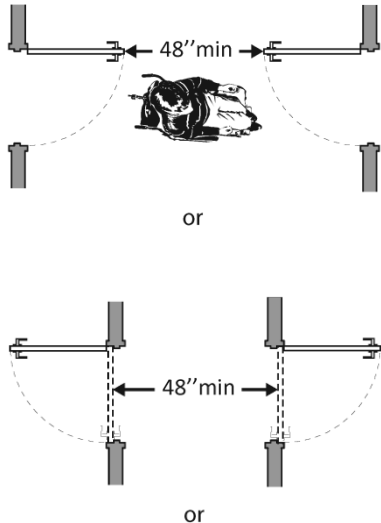
<p>after the 1991 ADA Standards went into effect (1/26/93)?</p> <p>Or</p> <p>No more than 3/4 inch high with the top 1/2 inch beveled no steeper than 1:2, if the threshold was installed before the 1991 ADA Standards went into effect (1/26/93)? [404.2.5, 303.2]</p> <p>Note: The first 1/4 inch of the 1/2 or 3/4 inch threshold may be vertical; the rest must be beveled.</p>	<p><input type="checkbox"/> Yes <input type="checkbox"/> No</p> <p>Measurement:</p>		<p>Photo #:</p>	
<p>1.44 Is the door equipped with hardware that is operable with one hand and does not require tight grasping, pinching or twisting of the wrist?</p> <p>Door handle?</p> <p>Lock (if provided)? [404.2.7]</p>	<p><input type="checkbox"/> Yes <input type="checkbox"/> No</p> <p><input type="checkbox"/> Yes <input type="checkbox"/> No</p> <p><input type="checkbox"/> Yes <input type="checkbox"/> No</p>		<p>Photo #:</p>	<ul style="list-style-type: none"> • Replace inaccessible knob with lever, loop or push hardware • Add automatic door opener •

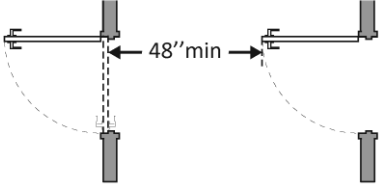
<p>1.45 Are the operable parts of the door hardware no less than 34 inches and no greater than 48 inches above the floor or ground surface? [404.2.7]</p>	<p><input type="checkbox"/> Yes <input type="checkbox"/> No</p> <p>Measurement:</p>		<p>Photo #:</p>	<ul style="list-style-type: none"> • Change hardware height • •
<p>1.46 If the door has a closer, does it take at least 5 seconds to close from an open position of 90 degrees to a position of 12 degrees from the latch? [404.2.8]</p>	<p><input type="checkbox"/> Yes <input type="checkbox"/> No</p> <p>Measurement:</p>		<p>Photo #:</p>	<ul style="list-style-type: none"> • Adjust closer • •
<p>1.47 If there are two doors in a series, e.g. vestibule, is the distance between the doors at least 48 inches plus the width of the doors when swinging into the space? [404.2.6]</p>	<p><input type="checkbox"/> Yes <input type="checkbox"/> No</p> <p>Measurement:</p>		<p>Photo #:</p>	<ul style="list-style-type: none"> • Remove inner door • Change door swing •

			<p>Photo #:</p>	
<p>1.48 If provided at the building entrance, are carpets or mats no higher than ½ inch thick? [302.2]</p>	<p><input type="checkbox"/> Yes <input type="checkbox"/> No Measurement:</p>		<p>Photo #:</p>	<ul style="list-style-type: none"> • Replace or remove mats • •
<p>1.49 Are edges of carpets or mats securely attached to minimize tripping hazards? [302.2]</p>	<p><input type="checkbox"/> Yes <input type="checkbox"/> No</p>		<p>Photo #:</p>	<ul style="list-style-type: none"> • Secure carpeting or mats at edges • •
	<p><input type="checkbox"/> Yes <input type="checkbox"/> No</p>		<p>Photo #:</p>	<ul style="list-style-type: none"> • • •
	<p><input type="checkbox"/> Yes <input type="checkbox"/> No</p>		<p>Photo #:</p>	<ul style="list-style-type: none"> • • •

ADA Checklist for Existing Facilities

Priority 2 – Access to Goods & Services

Based on the 2010 ADA Standards for Accessible Design

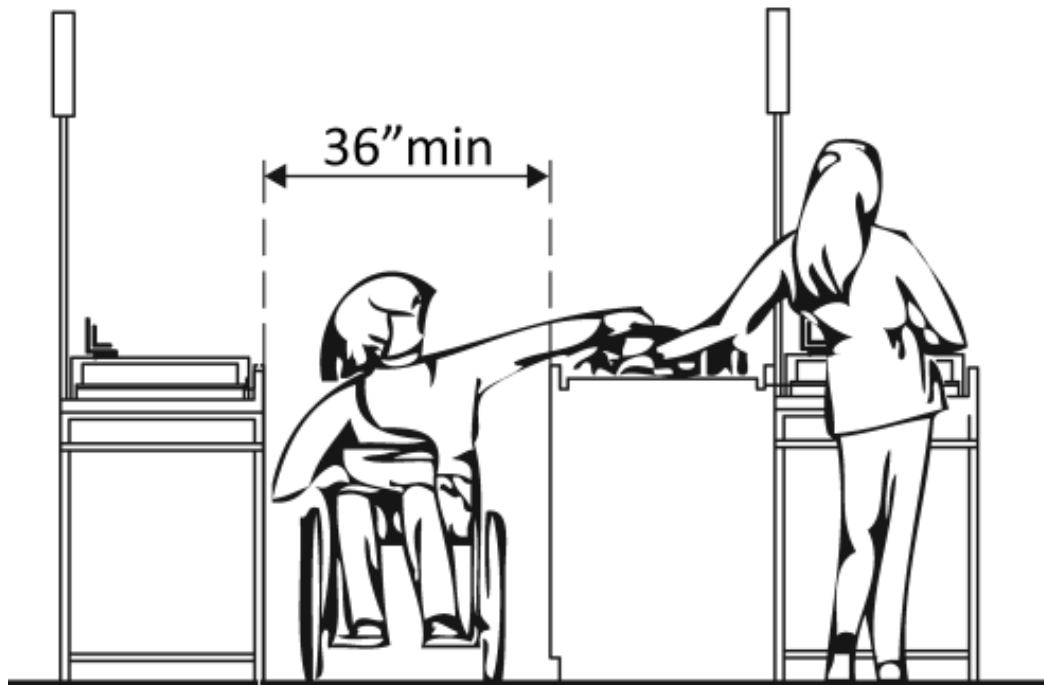

Project _____

Building _____

Location _____

Date _____

Surveyors _____

Contact Information _____

The layout of the building should allow people with disabilities to obtain goods and services and to participate in activities without assistance.



Institute for Human Centered Design
www.HumanCenteredDesign.org

2014



ADA National Network
Questions on the ADA 800-949-4232 voice/tty

www.ADAchecklist.org

This checklist was produced by the New England ADA Center, a project of the Institute for Human Centered Design and a member of the ADA National Network. This checklist was developed under a grant from the Department of Education, NIDRR grant number H133A060092-09A. However the contents do not necessarily represent the policy of the Department of Education, and you should not assume endorsement by the Federal Government.

Questions or comments on the checklist contact the New England ADA Center at 617-695-0085 voice/tty or ADAinfo@NewEnglandADA.org

For the full set of checklists, including the checklists for recreation facilities visit www.ADAchecklist.org.

Priority 2 – Access to Goods & Services		Comments	Possible Solutions
<p>2.1 Does the accessible entrance provide direct access to the main floor, lobby and elevator? [See 2010 ADA Standards for Accessible Design – 206.4]</p>	<input type="checkbox"/> Yes <input type="checkbox"/> No	<p>Photo #:</p>	<ul style="list-style-type: none"> • Create accessible route • •
Interior Accessible Route			
<p>2.2 Are all public spaces on at least one accessible route? [206.2.4]</p>	<input type="checkbox"/> Yes <input type="checkbox"/> No	<p>Photo #:</p>	<ul style="list-style-type: none"> • Create accessible route • •
<p>2.3 Is the route stable, firm and slip-resistant? [40.2, 302.1]</p>	<input type="checkbox"/> Yes <input type="checkbox"/> No	<p>Photo #:</p>	<ul style="list-style-type: none"> • Repair uneven surfaces • •
<p>2.4 Is the route at least 36 inches wide? [403.5.1]</p> <p>Note: The accessible route can narrow to 32 inches min. for a max. of 24 inches. These narrower portions of the route must be at least 48 inches from each other.</p>	<p>Measurement:</p>	<p>36" min</p> <p>24" max 48" min 24" max</p> <p>32" min 32" min</p>	<p>Photo #:</p> <ul style="list-style-type: none"> • Widen route • •

<p>2.5 If the route is greater than 200 feet in length and less than 60 inches wide, is there a passing space no less than 60 x 60 inches? [403.5.3]</p>	<p><input type="checkbox"/> Yes <input type="checkbox"/> No</p> <p>Measurement:</p>		<p>Photo #:</p>	<ul style="list-style-type: none"> • Widen route for passing space • •
<p>2.6 Is the running slope no steeper than 1:20, i.e. for every inch of height change there are at least 20 inches of route run? [403.3]</p> <p>Note: If the running slope is steeper than 1:20, treat as a ramp and add features such as edge protection and handrails.</p>	<p><input type="checkbox"/> Yes <input type="checkbox"/> No</p> <p>Measurement:</p>		<p>Photo #:</p>	<ul style="list-style-type: none"> • Regrade • •
<p>2.7 Is the cross slope no steeper than 1:48? [403.3]</p>	<p><input type="checkbox"/> Yes <input type="checkbox"/> No</p> <p>Measurement:</p>		<p>Photo #:</p>	<ul style="list-style-type: none"> • Regrade • •
<p>2.8 Do all objects on circulation paths through public areas, e.g. fire extinguishers, drinking fountains, signs, etc., protrude no more than 4 inches into the path? Or</p>	<p><input type="checkbox"/> Yes <input type="checkbox"/> No</p> <p>Measurement:</p>	<p>Or</p>	<p>Photo #:</p>	<ul style="list-style-type: none"> • Remove object • Add tactile warning such as permanent planter or partial walls •

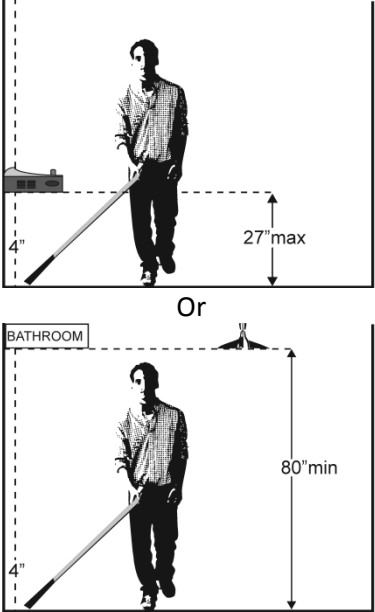
<p>If an object protrudes more than 4 inches, is the bottom leading edge at 27 inches or lower above the floor? [307.2]</p> <p>Or</p> <p>Is the bottom leading edge at 80 inches or higher above the floor? [307.4]</p>	<p><input type="checkbox"/> Yes <input type="checkbox"/> No</p> <p>Measurement:</p> <p><input type="checkbox"/> Yes <input type="checkbox"/> No</p> <p>Measurement:</p>		<p>Photo #:</p>	
<p>2.9 Are there elevators or platform lifts to all public stories?</p> <p>Note: Vertical access is not required in new construction or alterations if a facility is less than three stories or has less than 3,000 square feet per story, unless the facility is a shopping center, shopping mall, professional office of a health care provider, transportation terminal, state facility or local government facility</p>	<p><input type="checkbox"/> Yes <input type="checkbox"/> No</p>		<p>Photo #:</p>	<ul style="list-style-type: none"> • Install if necessary • Offer goods and services on an accessible story •

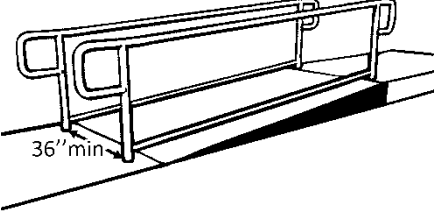
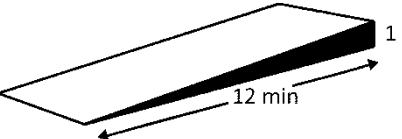
Ramps				
<p>2.10 If there is a ramp, is it at least 36 inches wide? [405.5]</p> <p>Note: If there are handrails, measure between the handrails.</p>	<p><input type="checkbox"/> Yes <input type="checkbox"/> No</p> <p>Measurement:</p>		<p>Photo #:</p>	<ul style="list-style-type: none"> • Alter ramp • •
<p>2.11 Is the surface stable, firm and slip resistant? [405.4]</p>	<p><input type="checkbox"/> Yes <input type="checkbox"/> No</p>		<p>Photo #:</p>	<ul style="list-style-type: none"> • Resurface ramp • •
<p>2.12 For each section of the ramp, is the running slope no greater than 1:12, i.e. for every inch of height change there are at least 12 inches of ramp run? [405.2]</p> <p>Note: Rises no greater than 3 inches with a slope no steeper than 1:8 and rises no greater than 6 inches with a slope no steeper than 1:10 are permitted when due to space limitations.</p>	<p><input type="checkbox"/> Yes <input type="checkbox"/> No</p> <p>Measurement:</p>		<p>Photo #:</p>	<ul style="list-style-type: none"> • Lengthen ramp to decrease slope • Relocate ramp •

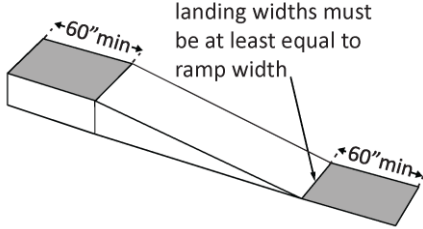
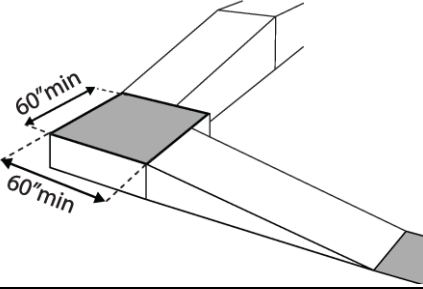
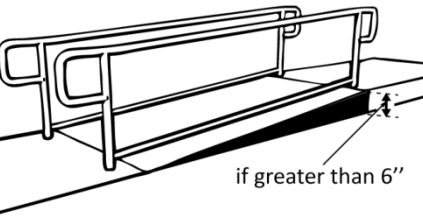

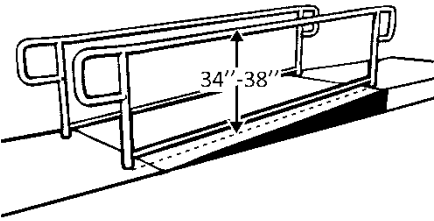
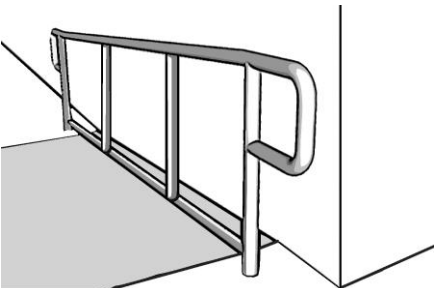
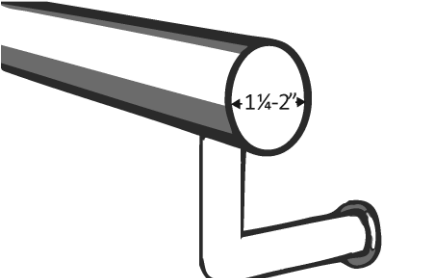
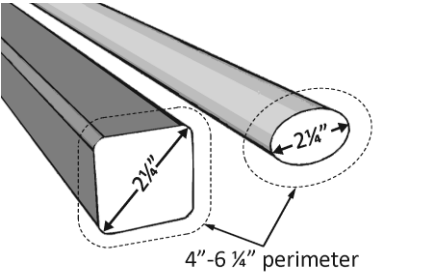
<p>2.13 Is there a level landing that is at least 60 inches long and at least as wide as the ramp:</p> <p>At the top of the ramp?</p> <p>At the bottom of the ramp? [405.7.2, 405.7.3]</p>	<p><input type="checkbox"/> Yes <input type="checkbox"/> No</p> <p>Measurement:</p> <p><input type="checkbox"/> Yes <input type="checkbox"/> No</p> <p>Measurement:</p>		<p>Photo #:</p>	<ul style="list-style-type: none"> • Alter ramp • Relocate ramp •
<p>2.14 Is there a level landing where the ramp changes direction that is at least 60 x 60 inches? [405.7.4]</p>	<p><input type="checkbox"/> Yes <input type="checkbox"/> No</p> <p>Measurement:</p>		<p>Photo #:</p>	<ul style="list-style-type: none"> • Increase landing size • •
<p>2.15 If the ramp has a rise higher than 6 inches are there handrails on both sides? [405.8]</p>	<p><input type="checkbox"/> Yes <input type="checkbox"/> No</p> <p>Measurement:</p>		<p>Photo #:</p>	<ul style="list-style-type: none"> • Add handrails • •

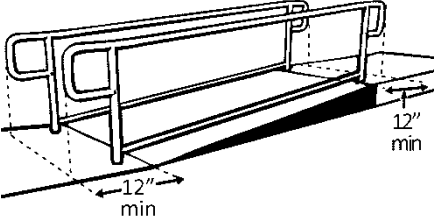
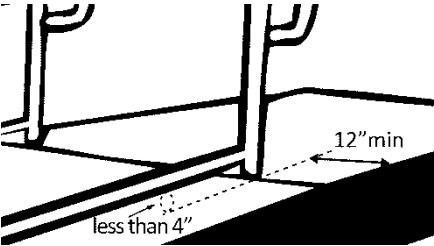

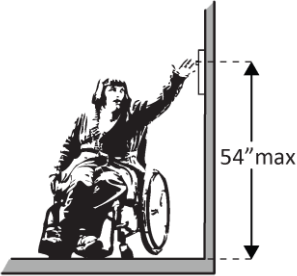
<p>2.16 Is the top of the handrail gripping surface no less than 34 inches and no greater than 38 inches above the ramp surface? [505.4]</p>	<p><input type="checkbox"/> Yes <input type="checkbox"/> No</p> <p>Measurement:</p>		<p>Photo #:</p>	<ul style="list-style-type: none"> • Adjust handrail height • •
<p>2.17 Is the handrail gripping surface continuous and not obstructed along the top or sides? [505.3]</p> <p>If there are obstructions, is the bottom of the gripping surface obstructed no more than 20%? [505.6]</p>	<p><input type="checkbox"/> Yes <input type="checkbox"/> No</p> <p><input type="checkbox"/> Yes <input type="checkbox"/> No</p> <p>Measurement:</p>		<p>Photo #:</p>	<ul style="list-style-type: none"> • Reconfigure or replace handrails • •
<p>2.18 If the handrail gripping surface is circular, is it no less than 1 ¼ inches and no greater than 2 inches in diameter? [505.7.1]</p>	<p><input type="checkbox"/> Yes <input type="checkbox"/> No</p> <p>Measurement:</p>		<p>Photo #:</p>	<ul style="list-style-type: none"> • Replace handrails • •
<p>2.19 If the handrail gripping surface is non-circular:</p> <p>Is the perimeter no less than 4 inches and no greater than 6 ¼ inches?</p>	<p><input type="checkbox"/> Yes <input type="checkbox"/> No</p> <p>Measurement:</p>		<p>Photo #:</p>	<ul style="list-style-type: none"> • Replace handrails • •

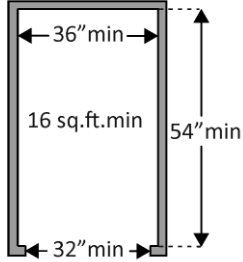
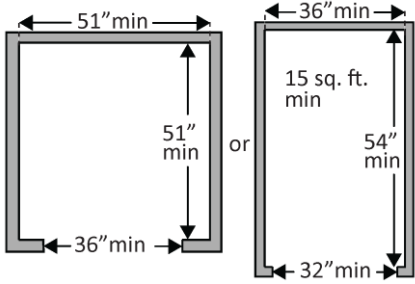
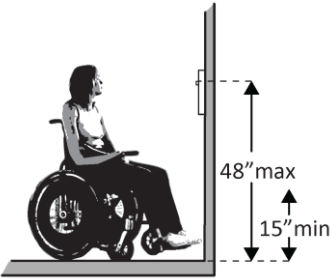
<p>Is the cross section no greater than 2¼ inches in diameter? [505.7.2]</p>	<p><input type="checkbox"/> Yes <input type="checkbox"/> No Measurement:</p>		<p>Photo #:</p>	
<p>2.20 Does the handrail:</p> <p>Extend at least 12 inches horizontally beyond the top and bottom of the ramp?</p> <p>Return to a wall, guard, or landing surface? [505.10.1]</p> <p>Note: If a 12" extension would be hazardous (in circulation path), it is not required</p>	<p><input type="checkbox"/> Yes <input type="checkbox"/> No Measurement:</p> <p><input type="checkbox"/> Yes <input type="checkbox"/> No Measurement:</p>		<p>Photo #:</p>	<ul style="list-style-type: none"> • Alter handrails • •
<p>2.21 To prevent wheelchair casters and crutch tips from falling off:</p> <p>Does the surface of the ramp extend at least 12 inches beyond the inside face of the handrail? Or Is there a curb or barrier that prevents the passage of a 4-inch diameter sphere? [405.9.1, 405.9.2]</p>	<p><input type="checkbox"/> Yes <input type="checkbox"/> No Measurement:</p> <p><input type="checkbox"/> Yes <input type="checkbox"/> No Measurement:</p>		<p>Photo #:</p>	<ul style="list-style-type: none"> • Add curb • Add barrier • Extend ramp width • •

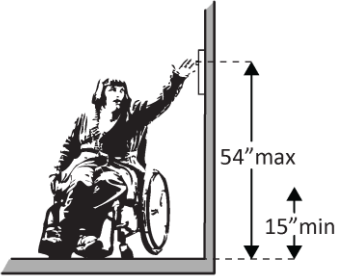
Elevators – Full Size & LULA (limited use, limited application) LULA elevators are often used in alterations.				
<p>2.22 If there is a full size or LULA elevator, are the call buttons no higher than 54 inches above the floor? [407.2.1.1]</p>	<p><input type="checkbox"/> Yes <input type="checkbox"/> No</p> <p>Measurement:</p>		<p>Photo #:</p>	<ul style="list-style-type: none"> • Change call button height • •
<p>2.23 If there is a full size or LULA elevator, does the sliding door reopen automatically when obstructed by an object or person?*</p> <p>[407.3.3]</p>	<p><input type="checkbox"/> Yes <input type="checkbox"/> No</p>		<p>Photo #:</p>	<p>* If constructed before 3/15/2012 and manually operated, the door is not required to reopen automatically</p> <ul style="list-style-type: none"> • Install opener •
<p>2.24 If there is a LULA elevator with a swinging door:</p> <p>Is the door power-operated?</p> <p>Does the door remain open for at least 20 seconds when activated?</p> <p>[403.3.2]</p>	<p><input type="checkbox"/> Yes <input type="checkbox"/> No</p> <p><input type="checkbox"/> Yes <input type="checkbox"/> No</p> <p>Time:</p>		<p>Photo #:</p>	<ul style="list-style-type: none"> • Add power operated door • Adjust opening time •

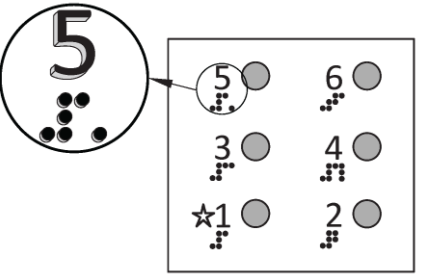
<p>2.25 If there is a full size elevator:</p> <p>Is the interior at least 54 inches deep by at least 36 inches wide with at least 16 sq. ft. of clear floor area?</p> <p>Is the door opening width at least 32 inches? [407.4.1 Exception]</p>	<p><input type="checkbox"/> Yes <input type="checkbox"/> No</p> <p>Measurement:</p> <p><input type="checkbox"/> Yes <input type="checkbox"/> No</p> <p>Measurement:</p>		<p>Photo #:</p>	<ul style="list-style-type: none"> • Replace elevator • •
<p>2.26 If there is a LULA elevator, is the interior:</p> <p>At least 51 inches deep by 51 inches wide with a door opening width of at least 36 inches?</p> <p>Or</p> <p>At least 54 inches deep by at least 36 inches wide with at least 15 sq. ft. of clear floor area and a door opening width of at least 32 inches? [408.4.1 Exceptions 1 and 2]</p>	<p><input type="checkbox"/> Yes <input type="checkbox"/> No</p> <p>Measurement:</p> <p><input type="checkbox"/> Yes <input type="checkbox"/> No</p> <p>Measurement:</p>		<p>Photo #:</p>	<ul style="list-style-type: none"> • Replace elevator • •
<p>2.27 If there is a full size or LULA elevator, are the in-car controls:</p> <p>No less than 15 inches and no greater 48 inches above the floor?</p> <p>Or</p>	<p><input type="checkbox"/> Yes <input type="checkbox"/> No</p> <p>Measurement:</p>	 <p>Or</p>	<p>Photo #:</p>	<ul style="list-style-type: none"> • Change control height • •

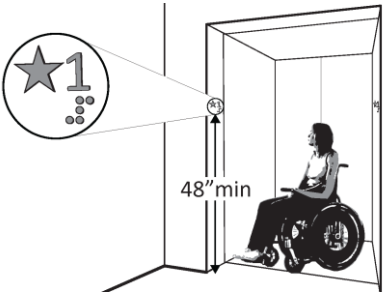
<p>Up to 54 inches above the floor for a parallel approach? [408.4.6, 407.4.6.1]</p>	<p><input type="checkbox"/> Yes <input type="checkbox"/> No</p> <p>Measurement:</p>		<p>Photo #:</p>	
<p>2.28 If there is a LULA elevator, are the in-car controls centered on a side wall? [408.4.6]</p>	<p><input type="checkbox"/> Yes <input type="checkbox"/> No</p> <p>Measurement:</p>		<p>Photo #:</p>	<ul style="list-style-type: none"> • Reconfigure controls • •
<p>2.29 If there is a full size or LULA elevator:</p> <p>Are the car control buttons designated with raised characters?</p> <p>Are the car control buttons designated with Braille? [407.4.7.1, 703.2]</p>	<p><input type="checkbox"/> Yes <input type="checkbox"/> No</p> <p><input type="checkbox"/> Yes <input type="checkbox"/> No</p>		<p>Photo #:</p>	<ul style="list-style-type: none"> • Add raised characters • Add Braille •
<p>2.30 If there is a full size or LULA elevator, are there audible signals which sound as the car passes or is about to stop at a floor? [407.4.8]</p>	<p><input type="checkbox"/> Yes <input type="checkbox"/> No</p>		<p>Photo #:</p>	<ul style="list-style-type: none"> • Install audible signals • •

<p>2.31 If there is a full size or LULA elevator:</p> <p>Is there a sign on both door jambs at every floor identifying the floor?</p> <p>Is there a tactile star on both jambs at the main entry level?</p> <p>Do text characters contrast with their backgrounds?</p> <p>Are text characters raised?</p> <p>Is there Braille?</p> <p>Is the sign mounted between 48 inches to the baseline of the lowest character and 60 inches to the baseline of the highest character above the floor?*</p> <p>[407.2.3, 408.2.3]</p>	<p><input type="checkbox"/> Yes <input type="checkbox"/> No</p> <p><input type="checkbox"/> Yes <input type="checkbox"/> No</p> <p><input type="checkbox"/> Yes <input type="checkbox"/> No</p> <p><input type="checkbox"/> Yes <input type="checkbox"/> No</p> <p><input type="checkbox"/> Yes <input type="checkbox"/> No</p> <p><input type="checkbox"/> Yes <input type="checkbox"/> No</p> <p>Measurement:</p>		<p>Photo #:</p>	<ul style="list-style-type: none"> • Install signs • Change sign height • • <p>* If constructed before 3/15/2012 and mounted no higher than 60 inches to the centerline of the sign, relocation is not required</p>
<p>Platform Lifts</p>				
<p>2.32 If a lift is provided, can it be used without assistance from others?</p> <p>[410.1]</p>	<p><input type="checkbox"/> Yes <input type="checkbox"/> No</p>		<p>Photo #:</p>	<ul style="list-style-type: none"> • Reconfigure so independently operable • •

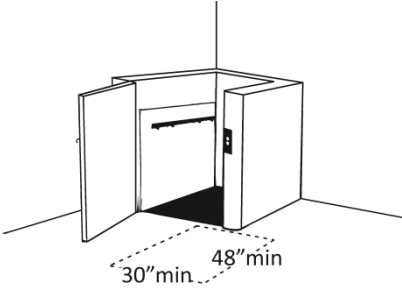
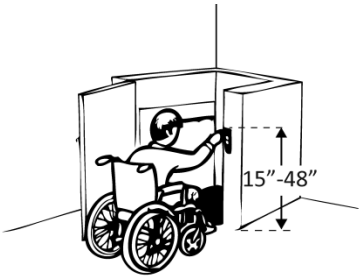
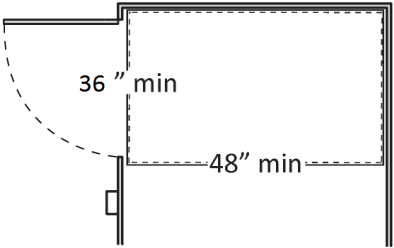
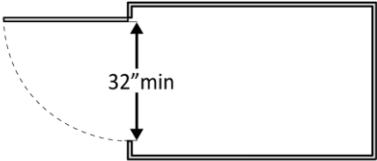
<p>2.33 Is there a clear floor space at least 30 inches wide by at least 48 inches long for a person using a wheelchair to approach and reach the controls to use the lift? [410.5]</p>	<p><input type="checkbox"/> Yes <input type="checkbox"/> No Measurement:</p>		<p>Photo #:</p>	<ul style="list-style-type: none"> • Remove obstructions • •
<p>2.34 Are the lift controls no less than 15 inches and no greater than 48 inches above the floor? [410.5]</p>	<p><input type="checkbox"/> Yes <input type="checkbox"/> No Measurement:</p>		<p>Photo #:</p>	<ul style="list-style-type: none"> • Change control height • •
<p>2.35 Is there a clear floor space at least 36 inches wide by at least 48 inches long inside the lift? [410.3]</p>	<p><input type="checkbox"/> Yes <input type="checkbox"/> No Measurement:</p>		<p>Photo #:</p>	<ul style="list-style-type: none"> • Replace lift • •
<p>2.36 If there is an end door, is the clear opening width at least 32 inches? [410.6]</p>	<p><input type="checkbox"/> Yes <input type="checkbox"/> No Measurement:</p>		<p>Photo #:</p>	<ul style="list-style-type: none"> • Alter door width • •

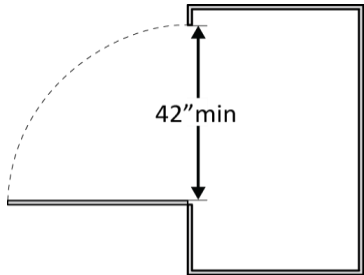
<p>2.37 If there is a side door, is the clear opening width at least 42 inches? [410.6]</p>	<p><input type="checkbox"/> Yes <input type="checkbox"/> No Measurement:</p>		<p>Photo #:</p>	<ul style="list-style-type: none"> • Alter door width • •
--	--	--	-----------------	--

Signs “Tactile characters” are read using touch, i.e. raised characters and Braille.

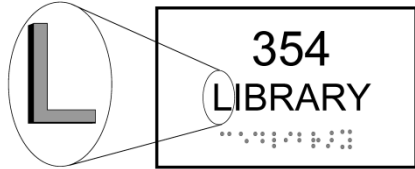
<p>2.38 If there are signs designating permanent rooms and spaces not likely to change over time, e.g. room numbers and letters, room names, and exit signs: [216.2]</p>	<p><input type="checkbox"/> Yes <input type="checkbox"/> No</p>		<ul style="list-style-type: none"> • Install tactile sign • Relocate sign •
<p>Do text characters contrast with their backgrounds? [703.5]</p>	<p><input type="checkbox"/> Yes <input type="checkbox"/> No</p>		
<p>Are text characters raised? [703.2]</p>	<p><input type="checkbox"/> Yes <input type="checkbox"/> No</p>		
<p>Is there Braille? [703.3]</p>	<p><input type="checkbox"/> Yes <input type="checkbox"/> No</p>		
<p>Is the sign mounted: On the wall on the latch side of the door? [703.4.2]</p>	<p><input type="checkbox"/> Yes <input type="checkbox"/> No</p>		
<p>Note: Signs are permitted on the push side of doors with closers and without hold-open devices.</p>			<p>*If constructed before 3/15/2012 and a person may approach within 3 inches of the sign without</p>

<p>With clear floor space beyond the arc of the door swing between the closed position and 45-degree open position, at least 18 x 18 inches centered on the tactile characters? * [703.4.2]</p> <p>So the baseline of the lowest character is at least 48 inches above the floor and the baseline of the highest character is no more than 60 inches above the floor? * [703.4.1]</p> <p>Note: If the sign is at double doors with one active leaf, the sign should be on the inactive leaf; if both leaves are active, the sign should be on the wall to the right of the right leaf.</p>	<p><input type="checkbox"/> Yes <input type="checkbox"/> No</p> <p>Measurement:</p> <p><input type="checkbox"/> Yes <input type="checkbox"/> No</p> <p>Measurement:</p>		<p>Photo #:</p>	<p>encountering protruding objects or standing within the door swing, relocation not required</p> <p>*If constructed before 3/15/2012 and mounted no higher than 60 inches to the centerline of the sign, relocation not required</p>
<p>2.39 If there are signs that provide direction to or information about interior spaces:</p> <p>Do text characters contrast with their backgrounds? [703.5.1]</p> <p>Is the sign mounted so that characters are at least 40 inches above the floor? [703.5.6]</p> <p>Note: Raised characters and Braille are not required.</p>	<p><input type="checkbox"/> Yes <input type="checkbox"/> No</p> <p><input type="checkbox"/> Yes <input type="checkbox"/> No</p> <p>Measurement:</p>		<p>Photo #:</p>	<ul style="list-style-type: none"> • Install signs with contrasting characters • Change sign height •

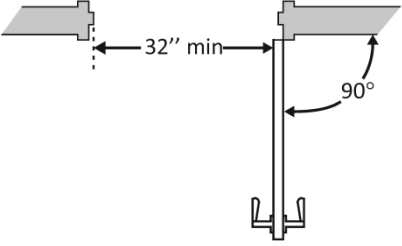
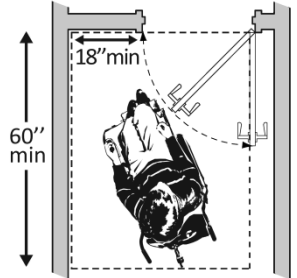
Interior Doors – to classrooms, medical exam rooms, conference rooms, etc.				
<p>2.40 Is the door opening width at least 32 inches clear, between the face of the door and the stop, when the door is open 90 degrees? [404.2.3]</p>	<p><input type="checkbox"/> Yes <input type="checkbox"/> No</p> <p>Measurement:</p>		<p>Photo #:</p>	<ul style="list-style-type: none"> • Install offset hinges • Alter the doorway •
<p>2.41 If there is a front approach to the pull side of the door, is there at least 18 inches of maneuvering clearance beyond the latch side plus at least 60 inches clear depth?</p> <p>Note: See 2010 Standards 404.2.4 for maneuvering clearance requirements on the push side of the door and side approaches to the pull side of the door.</p> <p>On both sides of the door, is the floor surface of the maneuvering clearance level (no steeper than 1:48)? [404.2.4]</p>	<p><input type="checkbox"/> Yes <input type="checkbox"/> No</p> <p>Measurement:</p> <p><input type="checkbox"/> Yes <input type="checkbox"/> No</p> <p>Measurement:</p>		<p>Photo #:</p>	<ul style="list-style-type: none"> • Remove obstructions • Reconfigure walls • Add automatic door opener

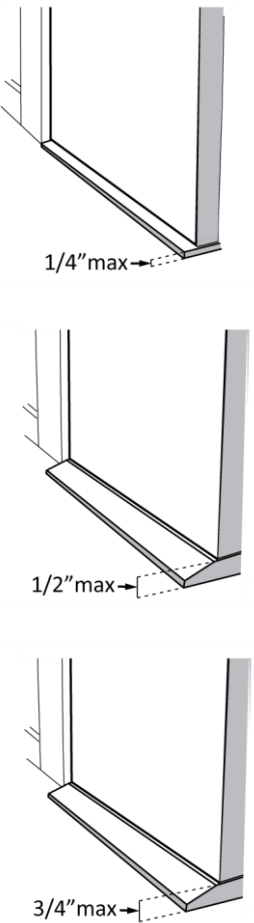
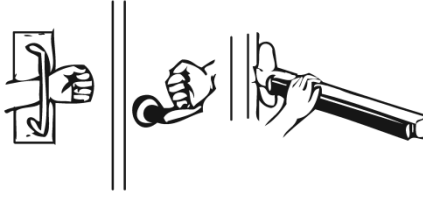
<p>2.42 If the threshold is vertical is it no more than ¼ inch high?</p> <p>Or</p> <p>No more than ½ inch high with the top ¼ inch beveled no steeper than 1:2, if the threshold was installed on or after the 1991 ADA Standards went into effect (1/26/93)?</p> <p>Or</p> <p>No more than ¾ inch high with the top ½ inch beveled no steeper than 1:2, if the threshold was installed before the 1991 ADA Standards went into effect (1/26/93)? [404.2.5, 303.2]</p> <p>Note: The first ¼ inch of the ½ or ¾ inch threshold may be vertical; the rest must be beveled.</p>	<p><input type="checkbox"/> Yes <input type="checkbox"/> No</p> <p>Measurement:</p> <p><input type="checkbox"/> Yes <input type="checkbox"/> No</p> <p>Measurement:</p> <p><input type="checkbox"/> Yes <input type="checkbox"/> No</p> <p>Measurement:</p>		<p>Photo #:</p>	<ul style="list-style-type: none"> • Remove or replace threshold • •
<p>2.43 Is the door equipped with hardware that is operable with one hand and does not require tight grasping, pinching or twisting of the wrist?</p> <p>Door handle?</p> <p>Lock (if provided)? [404.2.7]</p>	<p><input type="checkbox"/> Yes <input type="checkbox"/> No</p> <p><input type="checkbox"/> Yes <input type="checkbox"/> No</p> <p><input type="checkbox"/> Yes <input type="checkbox"/> No</p>		<p>Photo #:</p>	<ul style="list-style-type: none"> • Replace inaccessible knob with lever, loop or push hardware • Add automatic door opener •

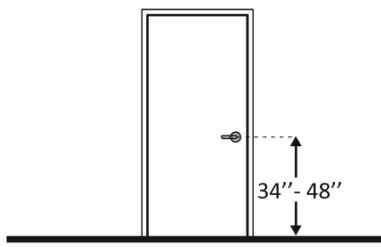
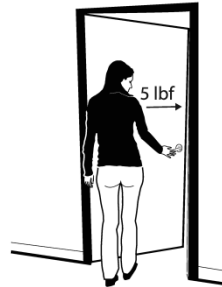
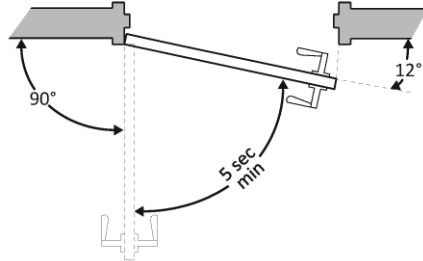
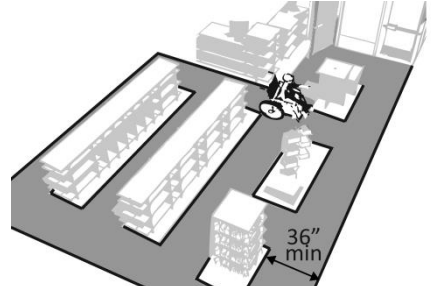
<p>2.44 Are the operable parts of the hardware no less than 34 inches and no greater than 48 inches above the floor? [404.2.7]</p>	<p><input type="checkbox"/> Yes <input type="checkbox"/> No</p> <p>Measurement:</p>		<p>Photo #:</p>	<ul style="list-style-type: none"> • Change hardware height • •
<p>2.45 Can the door be opened easily (5 pounds maximum force)? [404.2.9]</p> <p>Note: You can use a pressure gauge or fish scale to measure force. If you do not have one you will need to judge whether the door is easy to open.</p>	<p><input type="checkbox"/> Yes <input type="checkbox"/> No</p> <p>Measurement:</p>		<p>Photo #:</p>	<ul style="list-style-type: none"> • Adjust or replace closers • Install lighter doors • Install power-assisted or automatic door openers
<p>2.46 If the door has a closer, does it take at least 5 seconds to close from an open position of 90 degrees to a position of 12 degrees from the latch? [404.2.8.1]</p>	<p><input type="checkbox"/> Yes <input type="checkbox"/> No</p> <p>Measurement:</p>		<p>Photo #:</p>	<ul style="list-style-type: none"> • Adjust closer • •
<p>Rooms and Spaces – stores, supermarkets, libraries, etc.</p>				
<p>2.47 Are aisles and pathways to goods and services, and to one of each type of sales and service counters, at least 36 inches wide? [403.5.1]</p>	<p><input type="checkbox"/> Yes <input type="checkbox"/> No</p> <p>Measurement:</p>		<p>Photo #:</p>	<ul style="list-style-type: none"> • Rearrange goods, equipment and furniture • •

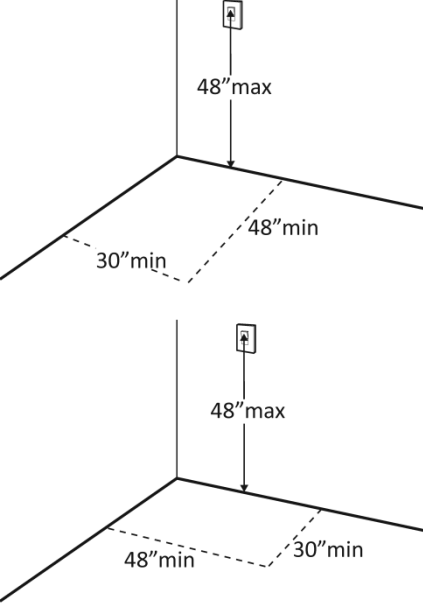
<p>2.48 Are floor surfaces stable, firm and slip resistant? [302.1]</p>	<p><input type="checkbox"/> Yes <input type="checkbox"/> No</p>		<p>Photo #:</p>	<ul style="list-style-type: none"> • Change floor surface • •
<p>2.49 If there is carpet: Is it no higher than ½ inch? Is it securely attached along the edges? [302.2]</p>	<p><input type="checkbox"/> Yes <input type="checkbox"/> No</p> <p>Measurement:</p> <p><input type="checkbox"/> Yes <input type="checkbox"/> No</p>		<p>Photo #:</p>	<ul style="list-style-type: none"> • Replace carpet • •
<p>Controls – light switches, security and intercom systems, emergency/alarm boxes, etc.</p>				
<p>2.50 Is there a clear floor space at least 30 inches wide by at least 48 inches long for a forward or parallel approach? [305.3]</p> <p>Are the operable parts no higher than 48 inches above the floor?*</p> <p>[309.3, 308]</p>	<p><input type="checkbox"/> Yes <input type="checkbox"/> No</p> <p>Measurement:</p> <p><input type="checkbox"/> Yes <input type="checkbox"/> No</p> <p>Measurement:</p>		<p>Photo #:</p>	<ul style="list-style-type: none"> • Change height of control • • <p>*If constructed before 3/15/2012 and a parallel approach is provided, controls can be 54 inches above the floor</p>

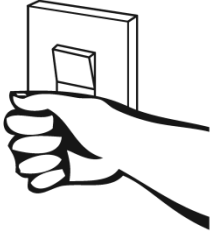

<p>2.51 Can the control be operated with one hand and without tight grasping, pinching, or twisting of the wrist? [309.4]</p>	<p><input type="checkbox"/> Yes <input type="checkbox"/> No</p>		<p>Photo #:</p>	<ul style="list-style-type: none"> • Replace control • •
--	---	--	-----------------	---

Seating: Assembly Areas – theaters, auditoriums, stadiums, theater style classrooms, etc.

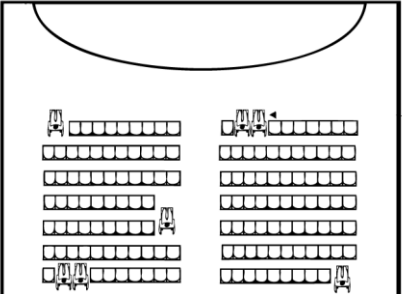
<p>2.52 Are an adequate number of wheelchair spaces provided? [221.2.1]</p>	<p><input type="checkbox"/> Yes <input type="checkbox"/> No</p> <p>Total #:</p> <p>Wheelchair #:</p>	<table border="1"> <thead> <tr> <th># of Seats</th> <th>Wheelchair Spaces</th> </tr> </thead> <tbody> <tr> <td>4 - 25</td> <td>1</td> </tr> <tr> <td>26 - 50</td> <td>2</td> </tr> <tr> <td>51 - 150</td> <td>4</td> </tr> <tr> <td>151 - 300</td> <td>5</td> </tr> <tr> <td colspan="2">300+ see 2010 Standards 221.2.1.</td> </tr> </tbody> </table>	# of Seats	Wheelchair Spaces	4 - 25	1	26 - 50	2	51 - 150	4	151 - 300	5	300+ see 2010 Standards 221.2.1.		<p>Photo #:</p>	<ul style="list-style-type: none"> • Reconfigure to add wheelchair spaces • •
# of Seats	Wheelchair Spaces															
4 - 25	1															
26 - 50	2															
51 - 150	4															
151 - 300	5															
300+ see 2010 Standards 221.2.1.																

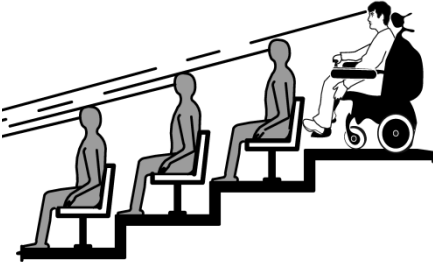
<p>2.53 Are wheelchair spaces dispersed to allow location choices and viewing angles equivalent to other seating, including specialty seating areas that provide distinct services and amenities? [221.2.3]</p>	<p><input type="checkbox"/> Yes <input type="checkbox"/> No</p>		<p>Photo #:</p>	<ul style="list-style-type: none"> • Reconfigure to disperse wheelchair spaces • •
--	---	---	-----------------	---

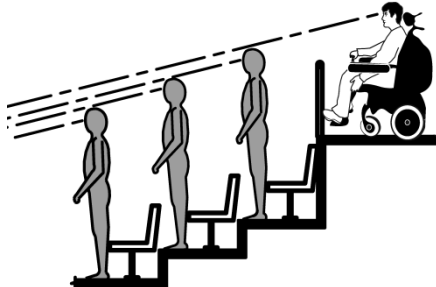
<p>2.54 Where people are expected to remain seated, do people in wheelchair spaces have a clear line of sight over and between the heads of others in front of them? [802.2.1.1, 802.1.1.2]</p>	<p><input type="checkbox"/> Yes <input type="checkbox"/> No</p>		<p>Photo #:</p>	<ul style="list-style-type: none"> • Alter for line of sight • •
--	---	--	-----------------	---

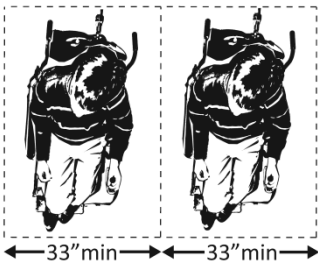
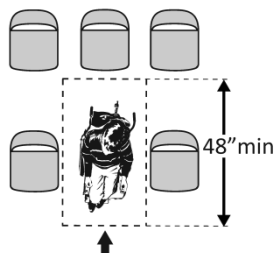
<p>2.55 Where people are expected to stand, do people in wheelchair spaces have a clear line of sight over and between the heads of others in front of them? [802.2.2.1, 802.1.2.2]</p>	<p><input type="checkbox"/> Yes <input type="checkbox"/> No</p>		<p>Photo #:</p>	<ul style="list-style-type: none"> • Alter for line of sight • •
<p>2.56 If there is a single wheelchair space, is it at least 36 inches wide? [802.1.2]</p>	<p><input type="checkbox"/> Yes <input type="checkbox"/> No</p> <p>Measurement:</p>		<p>Photo #:</p>	<ul style="list-style-type: none"> • Alter space • •
<p>2.57 If there are two adjacent wheelchair spaces, are they each at least 33 inches wide? [802.1.2]</p>	<p><input type="checkbox"/> Yes <input type="checkbox"/> No</p> <p>Measurement:</p>		<p>Photo #:</p>	<ul style="list-style-type: none"> • Alter spaces • •
<p>2.58 If the wheelchair space can be entered from the front or rear, is it at least 48 inches deep? [802.1.3]</p>	<p><input type="checkbox"/> Yes <input type="checkbox"/> No</p> <p>Measurement:</p>		<p>Photo #:</p>	<ul style="list-style-type: none"> • Alter space • •

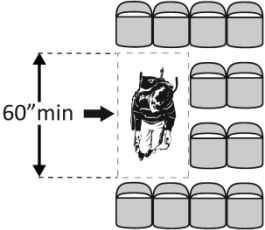
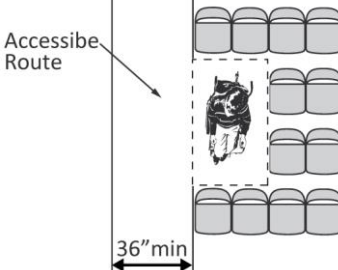
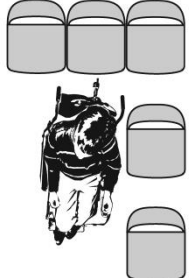
<p>2.59 If the wheelchair space can only be entered from the side, is it at least 60 inches deep? [802.1.3]</p>	<p><input type="checkbox"/> Yes <input type="checkbox"/> No</p> <p>Measurement:</p>		<p>Photo #:</p>	<ul style="list-style-type: none"> • Alter space • •
<p>2.60 Do wheelchair spaces adjoin, but not overlap, accessible routes? [802.1.4]</p>	<p><input type="checkbox"/> Yes <input type="checkbox"/> No</p>		<p>Photo #:</p>	<ul style="list-style-type: none"> • Alter spaces • •
<p>2.61 Is there at least one companion seat for each wheelchair space? [221.3]</p>	<p><input type="checkbox"/> Yes <input type="checkbox"/> No</p>		<p>Photo #:</p>	<ul style="list-style-type: none"> • Add companion seats • •
<p>2.62 Is the companion seat located so the companion is shoulder-to-shoulder with the person in a wheelchair? [802.3.1]</p>	<p><input type="checkbox"/> Yes <input type="checkbox"/> No</p>		<p>Photo #:</p>	<ul style="list-style-type: none"> • Alter seating • •
<p>2.63 Is the companion seat equivalent in size, quality, comfort and amenities to seating in the immediate area? [802.3.2]</p>	<p><input type="checkbox"/> Yes <input type="checkbox"/> No</p>		<p>Photo #:</p>	<ul style="list-style-type: none"> • Add equivalent seating • •

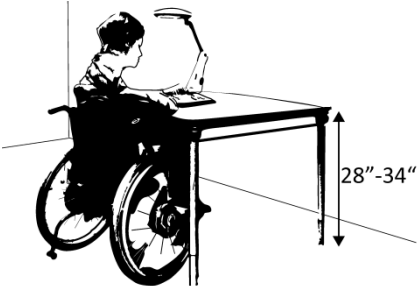
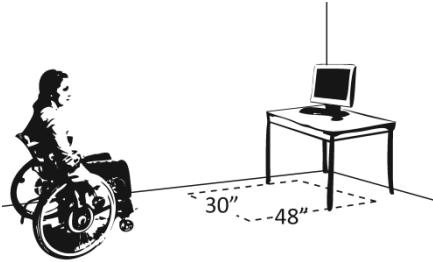
Seating: At dining surfaces (restaurants, cafeterias, bars, etc.) and non-employee work surfaces (libraries, conference rooms, etc.)				
<p>2.64 Are at least 5%, but no fewer than one, of seating and standing spaces accessible for people who use wheelchairs? [226.1]</p>	<p><input type="checkbox"/> Yes <input type="checkbox"/> No</p> <p>Total #:</p> <p>Wheelchair #:</p>		<p>Photo #:</p>	<ul style="list-style-type: none"> • Alter to provide accessible spaces • •
<p>2.65 Is there a route at least 36 inches wide to accessible seating? [403.5.1]</p>	<p><input type="checkbox"/> Yes <input type="checkbox"/> No</p> <p>Measurement:</p>		<p>Photo #:</p>	<ul style="list-style-type: none"> • Widen route • •
<p>2.66 At the accessible space(s), is the top of the accessible surface no less than 28 inches and no greater than 34 inches above the floor? [902.3]</p> <p>Note: If for children, the top should be no less than 26 inches and no greater than 30 inches above the floor.</p>	<p><input type="checkbox"/> Yes <input type="checkbox"/> No</p> <p>Measurement:</p>		<p>Photo #:</p>	<ul style="list-style-type: none"> • Alter surface height • •
<p>2.67 Is there a clear floor space at least 30 inches wide by at least 48 inches long for a forward approach? [305.3]</p>	<p><input type="checkbox"/> Yes <input type="checkbox"/> No</p> <p>Measurement:</p>		<p>Photo #:</p>	<ul style="list-style-type: none"> • Alter table or work surface • Add accessible table or work surface •

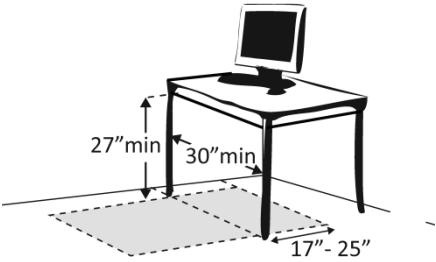
<p>Does it extend no less than 17 inches and no greater than 25 inches under the surface?</p> <p>Is there knee space at least 27 inches high and at least 30 inches wide? [306.2, 306.3]</p> <p>Note: If for children, the knee space may be 24 inches high.</p>	<p><input type="checkbox"/> Yes <input type="checkbox"/> No</p> <p>Measurement:</p> <p><input type="checkbox"/> Yes <input type="checkbox"/> No</p> <p>Measurement:</p>		<p>Photo #:</p>	
--	---	--	-----------------	--

Seating: General – reception areas, waiting rooms, etc.

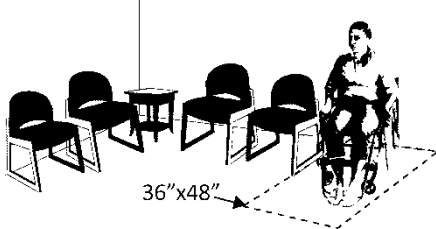
<p>2.68 Is there at least one space at least 36 inches wide by at least 48 inches long for a person in a wheelchair? [802.1.2, 802.1.3]</p>	<p><input type="checkbox"/> Yes <input type="checkbox"/> No</p> <p>Measurement:</p>		<p>Photo #:</p>	<ul style="list-style-type: none"> • Move furniture and equipment to provide space • •
--	---	--	-----------------	---



Benches – In locker rooms, dressing rooms, fitting rooms This section does not apply to any other benches.

<p>2.69 In locker rooms, dressing rooms and fitting rooms, is there at least one room with a bench? [222.1, 803.4]</p>	<p><input type="checkbox"/> Yes <input type="checkbox"/> No</p>		<p>Photo #:</p>	<ul style="list-style-type: none"> • Add bench • •
---	---	--	-----------------	---

<p>2.70 Is there a clear floor space at least 30 inches wide by at least 48 inches long at the end of the bench and parallel to the short axis of the bench?</p> <p>Is the bench seat at least 42 inches long and no less than 20 inches and no greater than 24 inches deep?</p> <p>Does the bench have back support or is it affixed to a wall?</p> <p>Is the top of the bench seat no less than 17 inches and no greater than 19 inches above the floor? [903]</p>	<p><input type="checkbox"/> Yes <input type="checkbox"/> No</p> <p>Measurement:</p> <p><input type="checkbox"/> Yes <input type="checkbox"/> No</p> <p>Measurement:</p> <p><input type="checkbox"/> Yes <input type="checkbox"/> No</p> <p>Measurement:</p> <p><input type="checkbox"/> Yes <input type="checkbox"/> No</p> <p>Measurement:</p>		<p>Photo #:</p>	<ul style="list-style-type: none"> • Move bench • Replace bench • Affix bench to wall • •
---	---	--	-----------------	--

Check-Out Aisles – supermarkets, large retail stores, etc.

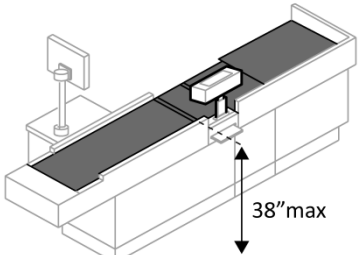
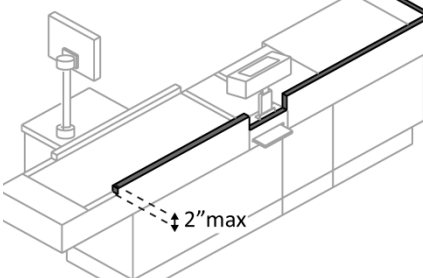
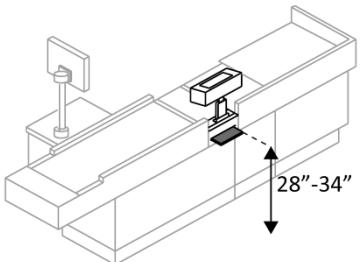
<p>2.71 Is the aisle at least 36 inches wide? [904.3.1]</p>	<p><input type="checkbox"/> Yes <input type="checkbox"/> No</p> <p>Measurement:</p>		<p>Photo #:</p>	<ul style="list-style-type: none"> • Widen aisle • •
--	---	--	-----------------	---

<p>2.72 Is the counter surface of at least one aisle no higher than 38 inches above the floor? [904.3.2]</p>	<p><input type="checkbox"/> Yes <input type="checkbox"/> No Measurement:</p>		<p>Photo #:</p>	<ul style="list-style-type: none"> • Lower counter • •
<p>2.73 Is the top of the counter edge protection no higher than 2 inches above the counter surface? [904.3.2]</p>	<p><input type="checkbox"/> Yes <input type="checkbox"/> No Measurement:</p>		<p>Photo #:</p>	<ul style="list-style-type: none"> • Lower edge protection • •
<p>2.74 If there is a check writing surface, is the top no less than 28 inches and no greater than 34 inches above the floor? [904.3.3]</p>	<p><input type="checkbox"/> Yes <input type="checkbox"/> No Measurement:</p>		<p>Photo #:</p>	<ul style="list-style-type: none"> • Alter check writing surface • •
<p>2.75 If there is more than one check-out aisle is there a sign with the International Symbol of Accessibility at the accessible aisle? [216.11]</p>	<p><input type="checkbox"/> Yes <input type="checkbox"/> No</p>		<p>Photo #:</p>	<ul style="list-style-type: none"> • Add sign • •

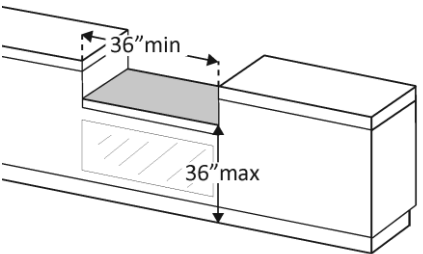
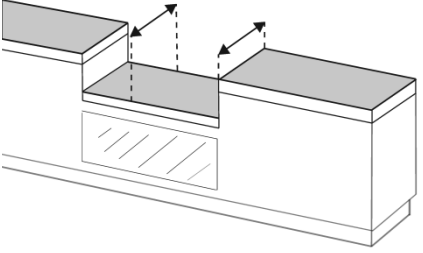
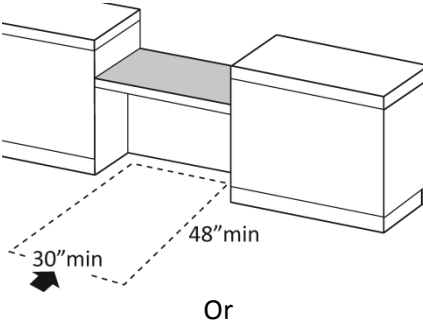
Sales & Service Counters – banks, stores, dry cleaners, auto repair shops, fitness clubs, etc.				
<p>2.76 Is there a portion of at least one of each type of counter that is:</p> <p>No higher than 36 inches above the floor?</p> <p>At least 36 inches long? [904.4.1]</p>	<p><input type="checkbox"/> Yes <input type="checkbox"/> No Measurement:</p> <p><input type="checkbox"/> Yes <input type="checkbox"/> No Measurement:</p>		<p>Photo #:</p>	<ul style="list-style-type: none"> • Lower section of counter • Lengthen section of counter •
<p>2.77 Does the accessible portion of the counter extend the same depth as the counter top? [904.4]</p>	<p><input type="checkbox"/> Yes <input type="checkbox"/> No Measurement:</p>		<p>Photo #:</p>	<ul style="list-style-type: none"> • Alter accessible portion • •
<p>2.78 Is there a clear floor space at least 30 inches wide by at least 48 inches long for a forward or parallel approach? [904.4]</p>	<p><input type="checkbox"/> Yes <input type="checkbox"/> No</p> <p><input type="checkbox"/> Parallel Measurement:</p> <p><input type="checkbox"/> Forward Measurement:</p>		<p>Photo #:</p>	<ul style="list-style-type: none"> • Reconfigure to provide a parallel or forward approach • •

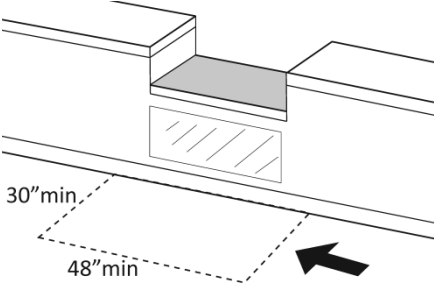
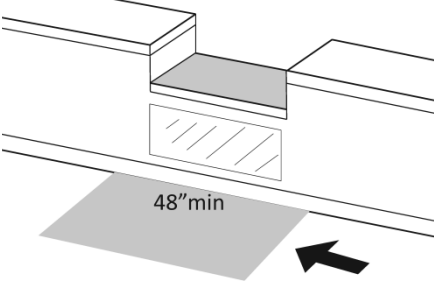
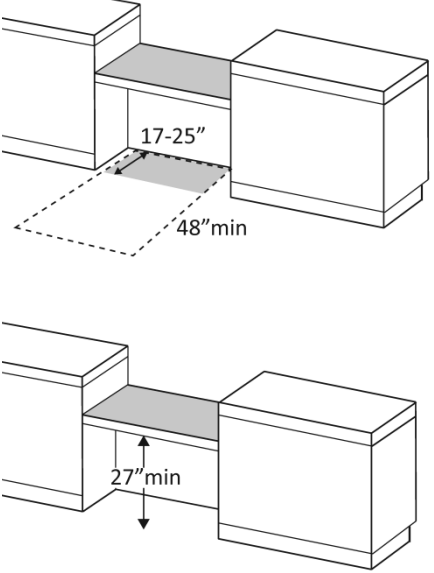
			<p>Photo #:</p>	
<p>2.79 For a parallel approach, is the clear floor space positioned with the 48 inches adjacent to the accessible length of counter? [904.4.1]</p>	<p><input type="checkbox"/> Yes <input type="checkbox"/> No</p> <p>Measurement:</p>		<p>Photo #:</p>	<ul style="list-style-type: none"> • If a parallel approach is not possible, a forward approach is required • •
<p>2.80 For a forward approach:</p> <p>Do no less than 17 and no greater than 25 inches of the clear floor space extend under the accessible length of the counter? [306.2.2, 306.2.3]</p> <p>Is there at least 27 inches clearance from the floor to the bottom of the counter? [306.3.1]</p>	<p><input type="checkbox"/> Yes <input type="checkbox"/> No</p> <p>Measurement:</p> <p><input type="checkbox"/> Yes <input type="checkbox"/> No</p> <p>Measurement:</p>		<p>Photo #:</p>	<ul style="list-style-type: none"> • Reconfigure to provide knee clearance • •

Food Service Lines – in cafeterias, salad bars, eat-in fast food establishments, etc.

2.81 Does at least one of each type of self-service shelf or dispensing device for tableware, dishware, condiments, food and beverages have a forward or parallel approach? [904.5.1]

- Yes No
- Forward
- Parallel

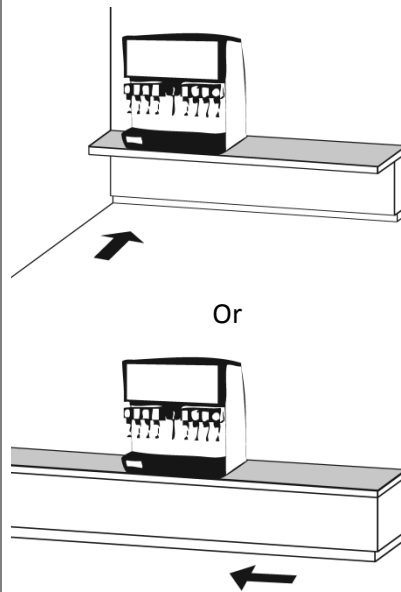

Photo #:

- Reconfigure to provide approach
-
-

2.82 If there is an unobstructed parallel approach, is the shelf or dispensing device no higher than 48 inches above the floor? [308.3.1]

- Yes No
- Measurement:

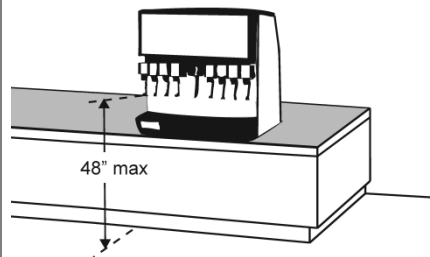

Photo #:

- Lower shelf and/or dispensing device
-
-

2.83 If there is a shallow obstruction no deeper than 10 inches with a parallel approach, is the shelf or dispensing device no higher than 48 inches above the floor? [308.3.1]

- Yes No
- Measurement:

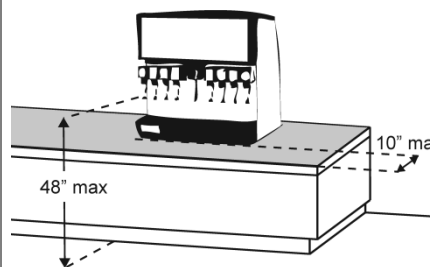
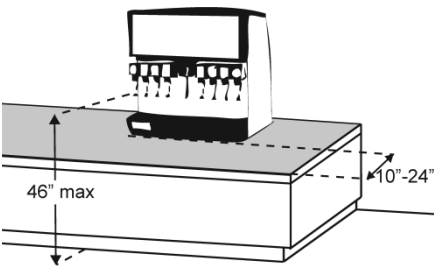
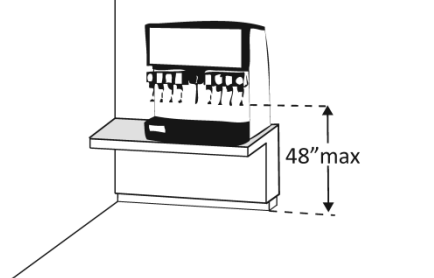
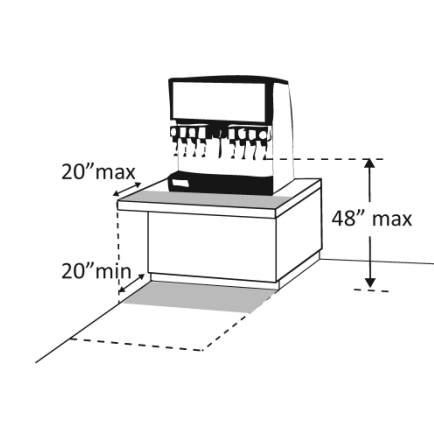
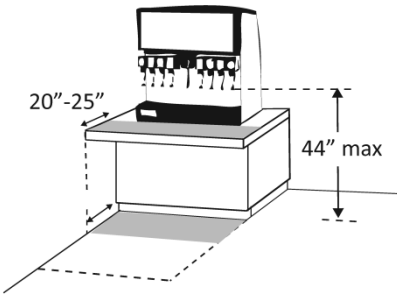
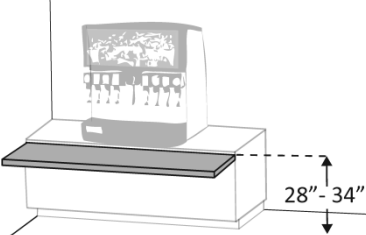

Photo #:

- Lower shelf and/or dispensing device
-
-

<p>2.84 If there is an obstruction no less than 10 inches and no greater than 24 inches deep with a parallel approach, is the shelf or dispensing device no higher than 46 inches above the floor? [308.3.2]</p>	<p><input type="checkbox"/> Yes <input type="checkbox"/> No Measurement:</p>		<p>Photo #:</p>	<ul style="list-style-type: none"> • Lower shelf and/or dispensing device • •
<p>2.85 If there is an unobstructed forward approach, is the shelf or dispensing device no higher than 48 inches above the floor? [308.2.1]</p>	<p><input type="checkbox"/> Yes <input type="checkbox"/> No Measurement:</p>		<p>Photo #:</p>	<ul style="list-style-type: none"> • Lower shelf and/or dispensing device • •
<p>2.86 If there is an obstruction no deeper than 20 inches with a forward approach: Does clear floor space extend under the obstruction that is at least the same depth as the obstruction? Is the shelf or dispensing device no higher than 48 inches above the floor? [904.5.1]</p>	<p><input type="checkbox"/> Yes <input type="checkbox"/> No Measurement: <input type="checkbox"/> Yes <input type="checkbox"/> No Measurement:</p>		<p>Photo #:</p>	<ul style="list-style-type: none"> • Reconfigure to provide knee space • Lower shelf and/or dispensing device •

<p>2.87 If the obstruction is no less than 20 inches and no greater than 25 inches deep with a forward approach:</p> <p>Does clear floor space extend under the obstruction that is at least the same depth as the obstruction?</p> <p>Is the shelf or dispensing device no higher than 44 inches above the floor? [904.5.1]</p>	<p><input type="checkbox"/> Yes <input type="checkbox"/> No Measurement:</p> <p><input type="checkbox"/> Yes <input type="checkbox"/> No Measurement:</p>		<p>Photo #:</p>	<ul style="list-style-type: none"> • Reconfigure to provide knee space • Lower shelf and/or dispensing device •
<p>2.88 If there is a tray slide, is the top no less than 28 inches and no greater than 34 inches above the floor? [904.5.2]</p>	<p><input type="checkbox"/> Yes <input type="checkbox"/> No Measurement:</p>		<p>Photo #:</p>	<ul style="list-style-type: none"> • Reconfigure • •
	<p><input type="checkbox"/> Yes <input type="checkbox"/> No</p>		<p>Photo #:</p>	<ul style="list-style-type: none"> • • •
	<p><input type="checkbox"/> Yes <input type="checkbox"/> No</p>		<p>Photo #:</p>	<ul style="list-style-type: none"> • • •

The ADA Checklist for Existing Facilities

Priority 3 - Toilet Rooms

Based on the 2010 ADA Standards for Accessible Design

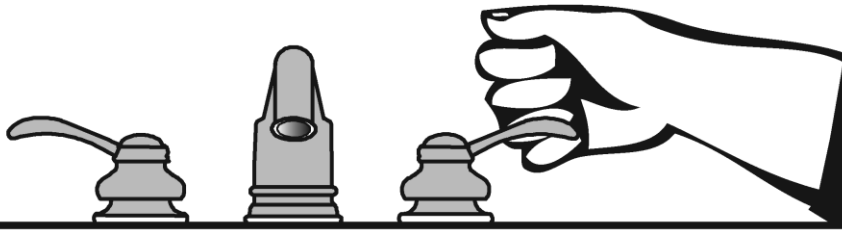

Project _____

Building _____

Location _____

Date _____

Surveyors _____

Contact Information _____

When toilet rooms are open to the public they should be accessible to people with disabilities.



Institute for Human Centered Design
www.HumanCenteredDesign.org

2014





ADA National Network
Questions on the ADA 800-949-4232 voice/tty

www.ADAchecklist.org

This checklist was produced by the New England ADA Center, a project of the Institute for Human Centered Design and a member of the ADA National Network. This checklist was developed under a grant from the Department of Education, NIDRR grant number H133A060092-09A. However the contents do not necessarily represent the policy of the Department of Education, and you should not assume endorsement by the Federal Government.

Questions or comments on the checklist contact the New England ADA Center at 617-695-0085 voice/tty or ADAinfo@NewEnglandADA.org

For the full set of checklists, including the checklists for recreation facilities visit www.ADAchecklist.org.

Priority 3 – Toilet Rooms		Comments	Possible Solutions
<p>3.1 If toilet rooms are available to the public, is at least one toilet room accessible? (Either one for each sex, or one unisex.)</p> <p>Note: If toilet rooms are chiefly for children, e.g., in elementary schools and day care centers, use the children’s specifications in Toilets - 604.1, 604.8, 604.9, 609.4 and Lavatories and Sinks – 606.2.</p>	<input type="checkbox"/> Yes <input type="checkbox"/> No	<p>Photo #:</p>	<ul style="list-style-type: none"> • Reconfigure toilet rooms • Combine toilet rooms to create one unisex accessible toilet room •
<p>3.2 Are there signs at inaccessible toilet rooms that give directions to accessible toilet rooms? [See 2010 ADA Standards for Accessible Design – 216.8]</p>	<input type="checkbox"/> Yes <input type="checkbox"/> No	 <p>Photo #:</p>	<ul style="list-style-type: none"> • Install signs • •
<p>3.3 If not all toilet rooms are accessible, is there a sign at the accessible toilet room with the International Symbol of Accessibility? [216.8]</p>	<input type="checkbox"/> Yes <input type="checkbox"/> No	 <p>Photo #:</p>	<ul style="list-style-type: none"> • Install sign • •
<p>Accessible Route</p>			
<p>3.4 Is there an accessible route to the accessible toilet room? [206.2.4]</p>	<input type="checkbox"/> Yes <input type="checkbox"/> No	<p>Photo #:</p>	<ul style="list-style-type: none"> • Alter route • •

Signs at Toilet Rooms

3.5 Do text characters contrast with their backgrounds? [703.5]

Yes No

Are text characters raised? [703.2]

Yes No

Is there Braille? [703.3]

Yes No

Is the sign mounted:
On the wall on the latch side of the door? [703.4.2]

Yes No

Note: Signs are permitted on the push side of doors with closers and without hold-open devices.

With clear floor space beyond the arc of the door swing between the closed position and 45-degree open position, at least 18 x 18 inches centered on the tactile characters? * [703.4.2]

Yes No

Measurement:

So the baseline of the lowest character is at least 48 inches above the floor and the baseline of the highest character is no more than 60 inches above the floor? * [703.4.1]

Yes No

Measurement:

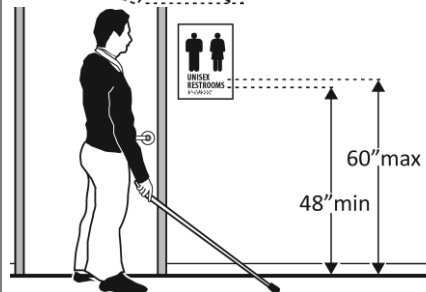
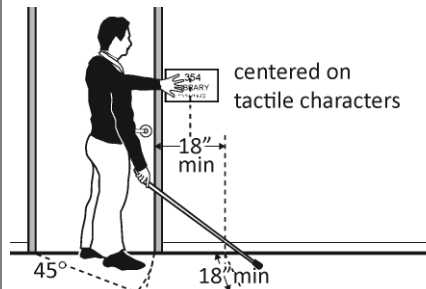
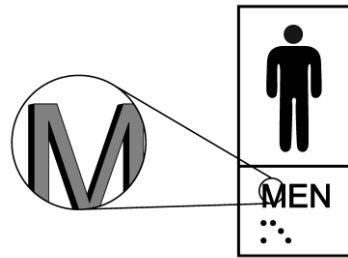

- Install tactile sign
- Relocate sign
-

*If constructed before 3/15/2012 and a person may approach within 3 inches of the sign without encountering protruding objects or standing within the door swing, relocation not required

*If constructed before 3/15/2012 and mounted no higher than 60 inches to the centerline of the

Note: If the sign is at double doors with one active leaf, the sign should be on the inactive leaf; if both leaves are active, the sign should be on the wall to the right of the right leaf.

sign, relocation is not required

Photo #:

Entrance

3.6 Is the door opening width at least 32 inches clear, between the face of the door and the stop, when the door is open 90 degrees?
[404.2.3]

Yes No

Measurement:

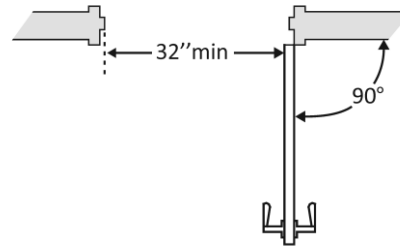

- Install offset hinges
- Alter the doorway
-

Photo #:

3.7 If there is a front approach to the pull side of the door is there at least 18 inches of maneuvering clearance beyond the latch side plus 60 inches clear depth?

Yes No

Measurement:

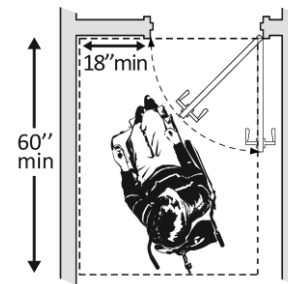

- Remove obstructions
- Reconfigure walls
- Add automatic door opener



Note: See 2010 Standards 404.2.4 for maneuvering clearance requirements on the push side of the door and side approaches to the pull side of the door

On both sides of the door, is the floor surface of the maneuvering clearance level (no steeper than 1:48)?
[404.2.4]

Yes No

Measurement:

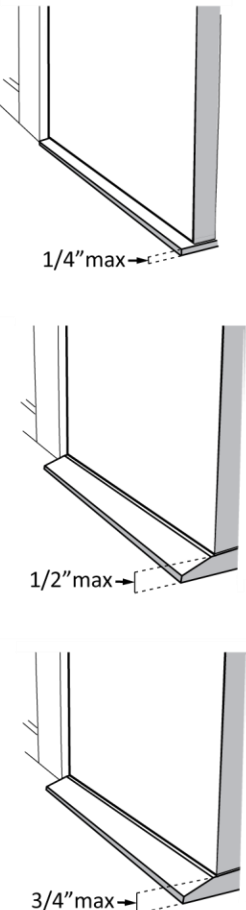
Photo #:

<p>3.8 If the threshold is vertical is it no more than ¼ inch high?</p> <p>Or</p> <p>No more than ½ inch high with the top ¼ inch beveled no steeper than 1:2, if the threshold was installed on or after the 1991 ADA Standards went into effect (1/26/93)?</p> <p>Or</p> <p>No more than ¾ inch high with the top ½ inch beveled no steeper than 1:2, if the threshold was installed before the 1991 ADA Standards went into effect (1/26/93)? [404.2.5, 303.2]</p> <p>Note: The first ¼ inch of the ½ or ¾ inch threshold may be vertical; the rest must be beveled.</p>	<p><input type="checkbox"/> Yes <input type="checkbox"/> No</p> <p>Measurement:</p> <p><input type="checkbox"/> Yes <input type="checkbox"/> No</p> <p>Measurement:</p> <p><input type="checkbox"/> Yes <input type="checkbox"/> No</p> <p>Measurement:</p>		<p>Photo #:</p>	<ul style="list-style-type: none"> • Remove or replace threshold • •
<p>3.9 Is the door equipped with hardware that is operable with one hand and does not require tight grasping, pinching or twisting of the wrist?</p> <p>Door handle?</p> <p>Lock (if provided)? [404.2.7]</p>	<p><input type="checkbox"/> Yes <input type="checkbox"/> No</p> <p><input type="checkbox"/> Yes <input type="checkbox"/> No</p> <p><input type="checkbox"/> Yes <input type="checkbox"/> No</p>		<p>Photo #:</p>	<ul style="list-style-type: none"> • Replace inaccessible knob with lever, loop or push hardware • Add automatic door opener •

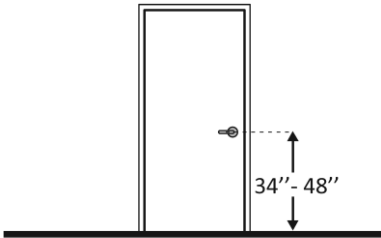
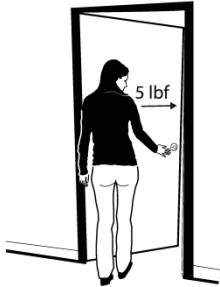
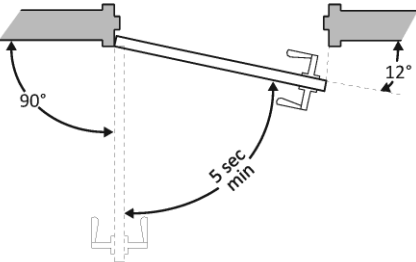
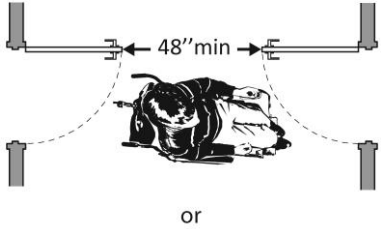

<p>3.10 Are the operable parts of the door hardware mounted no less than 34 inches and no greater than 48 inches above the floor? [404.2.7]</p>	<p><input type="checkbox"/> Yes <input type="checkbox"/> No</p> <p>Measurement:</p>		<p>Photo #:</p>	<ul style="list-style-type: none"> • Change hardware height • •
<p>3.11 Can the door be opened easily (5 pounds maximum force)? [404.2.9]</p> <p>Note: You can use a pressure gauge or fish scale to measure force. If you do not have one you will need to judge whether the door is easy to open.</p>	<p><input type="checkbox"/> Yes <input type="checkbox"/> No</p> <p>Measurement:</p>		<p>Photo #:</p>	<ul style="list-style-type: none"> • Adjust or replace closers • Install lighter doors • Install power-assisted or automatic door openers
<p>3.12 If the door has a closer, does it take at least 5 seconds to close from an open position of 90 degrees to a position of 12 degrees from the latch? [404.2.8.1]</p>	<p><input type="checkbox"/> Yes <input type="checkbox"/> No</p> <p>Measurement:</p>		<p>Photo #:</p>	<ul style="list-style-type: none"> • Adjust closer • •
<p>3.13 If there are two doors in a series, e.g. vestibule, is the distance between the doors at least 48 inches plus the width of the doors when swinging into the space? [404.2.6]</p>	<p><input type="checkbox"/> Yes <input type="checkbox"/> No</p> <p>Measurement:</p>	 <p style="text-align: center;">or</p>	<p>Photo #:</p>	<ul style="list-style-type: none"> • Remove inner door • Change door swing •

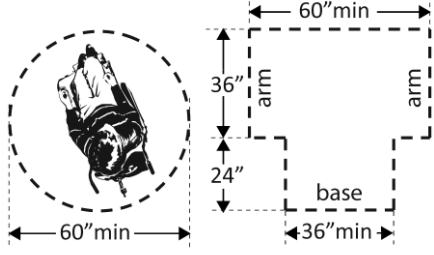
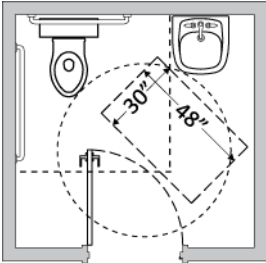
		<p style="text-align: center;">or</p>	<p>Photo #:</p>	
<p>3.14 If there is a privacy wall and the door swings out, is there at least 24 inches of maneuvering clearance beyond the door latch side and 42 inches to the privacy wall? [404.2.4]</p>	<p><input type="checkbox"/> Yes <input type="checkbox"/> No</p> <p>Measurement:</p>		<p>Photo #:</p>	<ul style="list-style-type: none"> • Reconfigure space • •
<p>3.15 If there is a privacy wall and the door swings in, is there at least 24 inches of maneuvering clearance beyond the door latch side and at least 48 inches to the privacy wall if there is no door closer or at least 54 inches if there is a door closer? [404.2.4]</p>	<p><input type="checkbox"/> Yes <input type="checkbox"/> No</p> <p>Measurement:</p>		<p>Photo #:</p>	<ul style="list-style-type: none"> • Reconfigure space • •

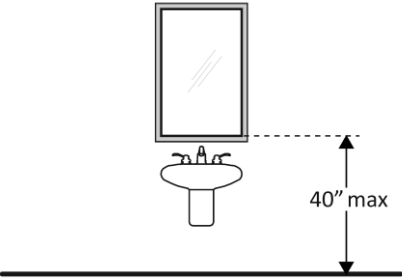
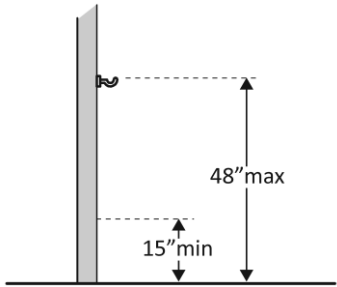
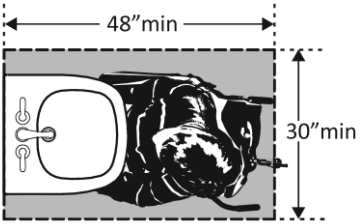
In the Toilet Room				
<p>3.16 Is there a clear path to at least one of each type of fixture, e.g. lavatory, hand dryer, etc., that is at least 36 inches wide? [403.5.1]</p>	<p><input type="checkbox"/> Yes <input type="checkbox"/> No</p> <p>Measurement:</p>	 <p>A diagram showing a wheelchair positioned between two horizontal lines representing a clear path. A vertical double-headed arrow between the lines is labeled "36'' min".</p>	<p>Photo #:</p>	<ul style="list-style-type: none"> • Remove obstructions • •
<p>3.17 Is there clear floor space available for a person in a wheelchair to turn around, i.e. a circle at least 60 inches in diameter or a T-shaped space within a 60-inch square? [603.2.1]</p>	<p><input type="checkbox"/> Yes <input type="checkbox"/> No</p> <p>Measurement:</p>	 <p>A diagram showing a wheelchair inside a dashed circle labeled "60'' min". To the right is a T-shaped dashed outline. The top horizontal bar of the T is labeled "60'' min". The vertical stem is labeled "36''" with "arm" written vertically on both sides. The bottom horizontal bar is labeled "36'' min" with "base" written below it.</p>	<p>Photo #:</p>	<ul style="list-style-type: none"> • Move or remove partitions, fixtures or objects such as trash cans • •
<p>3.18 In a single user toilet room if the door swings in and over a clear floor space at an accessible fixture, is there a clear floor space at least 30 x 48 inches beyond the swing of the door? [603.2.3 Exception 2]</p>	<p><input type="checkbox"/> Yes <input type="checkbox"/> No</p> <p>Measurement:</p>	 <p>A floor plan diagram of a toilet room. A dashed circle representing a 30x48 inch clear floor space is drawn outside the door's swing. The dimensions "30" and "48" are shown along the sides of the circle.</p>	<p>Photo #:</p>	<ul style="list-style-type: none"> • Reverse door swing • Alter toilet room •
<p>3.19 If the mirror is over a lavatory or countertop, is the bottom edge of the reflecting surface no higher than 40 inches above the floor? Or</p>	<p><input type="checkbox"/> Yes <input type="checkbox"/> No</p> <p>Measurement:</p>	<p style="text-align: center;">-</p>	<p>Photo #:</p>	<p>* If installed before 3/15/2012 and the bottom edge of the reflecting surface is no higher than 40 inches above the floor, lowering the mirror to 35 inches is</p>

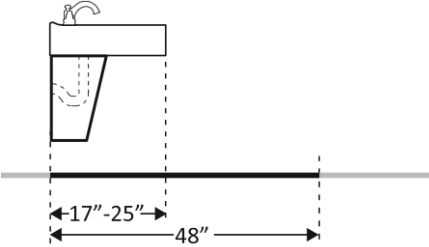
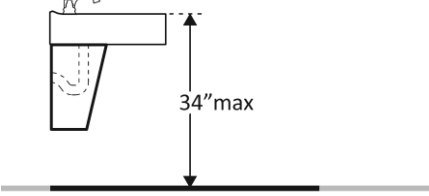
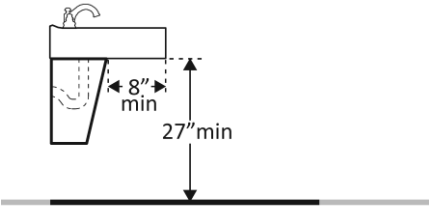
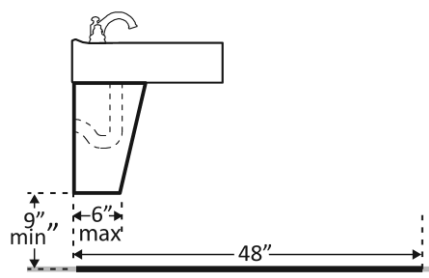
<p>If the mirror is not over the lavatory or countertop, is the bottom edge of the reflecting surface no higher than 35 inches above the floor?*</p> <p>[603.3]</p>	<p><input type="checkbox"/> Yes <input type="checkbox"/> No</p> <p>Measurement:</p>		<p>Photo #:</p>	<p>not required</p> <ul style="list-style-type: none"> • Lower the mirror • Add another mirror •
<p>3.20 If there is a coat hook, is it no less than 15 inches and no greater than 48 inches above the floor?*</p> <p>[603.4]</p>	<p><input type="checkbox"/> Yes <input type="checkbox"/> No</p> <p>Measurement:</p>		<p>Photo #:</p>	<ul style="list-style-type: none"> • Adjust hook • Replace with or provide additional accessible hook • <p>* If installed before 3/15/2010 and the clear floor space allows a parallel approach, the coat hook may be 54 inches above the floor.</p>
<p>Lavatories The 2010 Standards refer to sinks in toilet rooms as lavatories.</p>				
<p>3.21 Does at least one lavatory have a clear floor space for a forward approach at least 30 inches wide and 48 inches long?</p> <p>[606.2]</p>	<p><input type="checkbox"/> Yes <input type="checkbox"/> No</p> <p>Measurement:</p>		<p>Photo #:</p>	<ul style="list-style-type: none"> • Alter lavatory • Replace lavatory •

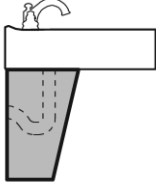
<p>3.22 Do no less than 17 inches and no greater than 25 inches of the clear floor space extend under the lavatory so that a person using a wheelchair can get close enough to reach the faucet? [306.2]</p>	<p><input type="checkbox"/> Yes <input type="checkbox"/> No</p> <p>Measurement:</p>		<p>Photo #:</p>	<ul style="list-style-type: none"> • Alter lavatory • Replace lavatory •
<p>3.23 Is the front of the lavatory or counter surface, whichever is higher, no more than 34 inches above the floor? [606.3]</p>	<p><input type="checkbox"/> Yes <input type="checkbox"/> No</p> <p>Measurement:</p>		<p>Photo #:</p>	<ul style="list-style-type: none"> • Alter lavatory • Replace lavatory •
<p>3.24 Is there at least 27 inches clearance from the floor to the bottom of the lavatory that extends at least 8 inches under the lavatory for knee clearance? [306.3.3]</p>	<p><input type="checkbox"/> Yes <input type="checkbox"/> No</p> <p>Measurement:</p>		<p>Photo #:</p>	<ul style="list-style-type: none"> • Alter lavatory • Replace lavatory •
<p>3.25 Is there toe clearance at least 9 inches high? [306.3.3]</p> <p>Note: Space extending greater than 6 inches beyond the available toe clearance at 9 inches above the floor is not considered toe clearance.</p>	<p><input type="checkbox"/> Yes <input type="checkbox"/> No</p>		<p>Photo #:</p>	<ul style="list-style-type: none"> • Alter lavatory • Replace lavatory •

<p>3.26 Are pipes below the lavatory insulated or otherwise configured to protect against contact? [606.5]</p>	<p><input type="checkbox"/> Yes <input type="checkbox"/> No</p>		<p>Photo #:</p>	<ul style="list-style-type: none"> • Install insulation • Install cover panel •
<p>3.27 Can the faucet be operated without tight grasping, pinching, or twisting of the wrist? Is the force required to activate the faucet no greater than 5 pounds? [606.4]</p>	<p><input type="checkbox"/> Yes <input type="checkbox"/> No</p> <p><input type="checkbox"/> Yes <input type="checkbox"/> No</p>		<p>Photo #:</p>	<ul style="list-style-type: none"> • Adjust faucet • Replace faucet •

Soap Dispensers and Hand Dryers

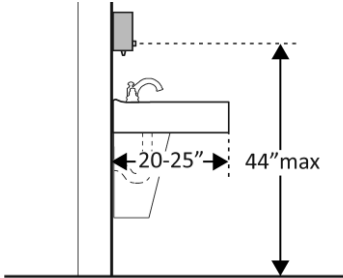
<p>3.28 Are the operable parts of the soap dispenser within one of the following reach ranges:</p> <p>Above lavatories or counters no less than 20 inches and no greater than 25 inches deep: no higher than 44 inches above the floor? [308.2.2]</p> <p>Above lavatories less than 20 inches deep: no higher than 48 inches above the floor?</p>	<p><input type="checkbox"/> Yes <input type="checkbox"/> No Measurement:</p> <p><input type="checkbox"/> Yes <input type="checkbox"/> No Measurement:</p>		<p>Photo #:</p>	<ul style="list-style-type: none"> • Adjust dispensers • Replace with or provide additional accessible dispensers •
--	---	---	-----------------	--

Not over an obstruction: no higher than 48 inches above the floor?
[308.2]

Yes No

Measurement:

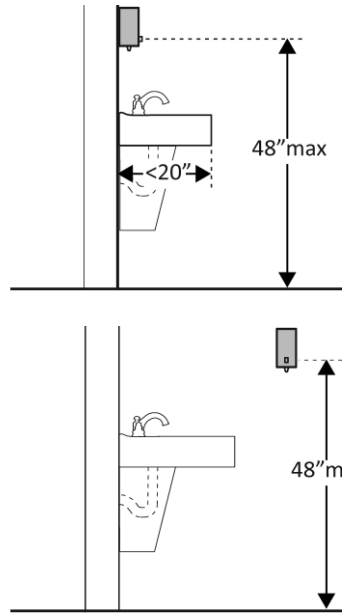

Photo #:

3.29 Are the operable parts of the hand dryer or towel dispenser within one of the following reach ranges:

Above lavatories or counters no less than 20 inches and no greater than 25 inches deep: no higher than 44 inches above the floor?

Yes No

Measurement:

Above lavatories less than 20 inches deep: no higher than 48 inches above the floor?

Yes No

Measurement:

Not over an obstruction: no higher than 48 inches above the floor?
[308.2]

Yes No

Measurement:

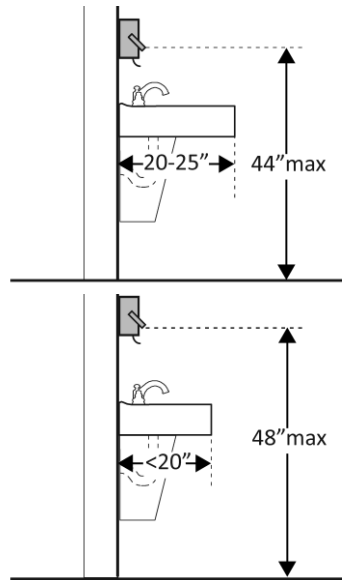

- Adjust dispensers
- Replace with or provide additional accessible dispensers
-

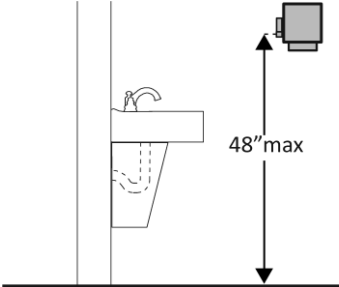
<p>Can the operable parts of the hand dryer or towel dispenser be operated without tight grasping, pinching or twisting of the wrist?</p> <p>Is the force required to activate the hand dryer or towel dispenser no greater than 5 pounds? [309.4]</p>	<p><input type="checkbox"/> Yes <input type="checkbox"/> No</p> <p><input type="checkbox"/> Yes <input type="checkbox"/> No</p> <p>Measurement:</p>		<p>Photo #:</p>	
--	---	--	-----------------	--

Water Closets in Single-User Toilet Rooms and Compartments (Stalls) The 2010 Standards refer to toilets as water closets.

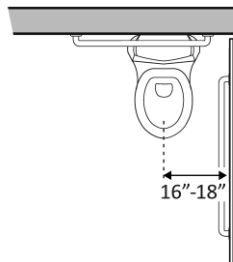
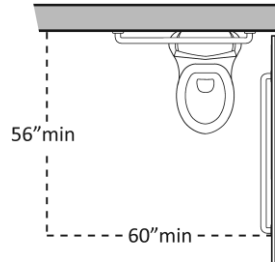
<p>3.30 Is the centerline of the water closet no less than 16 inches and no greater than 18 inches from the side wall or partition? [604.2]</p>	<p><input type="checkbox"/> Yes <input type="checkbox"/> No</p> <p>Measurement:</p>		<p>Photo #:</p>	<ul style="list-style-type: none"> • Move toilet • Replace toilet • Move partition •
<p>3.31 Is clearance provided around the water closet measuring at least 60 inches from the side wall and at least 56 inches from the rear wall?*</p> <p>[604.3.1]</p>	<p><input type="checkbox"/> Yes <input type="checkbox"/> No</p> <p>Measurement:</p>		<p>Photo #:</p>	<p>* If constructed before 3/15/12, clearances around water closets in single user toilet rooms can be 48 inches wide by 66 inches long or 48 inches wide by 56 inches long (depending on the approach to the water closet, see 1991 Standards Figure 28) and the lavatory may overlap that clearance if the door to the room does</p>

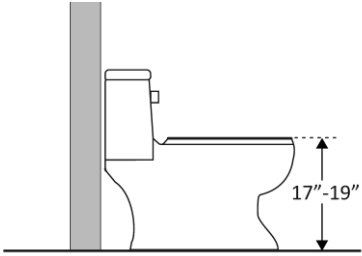
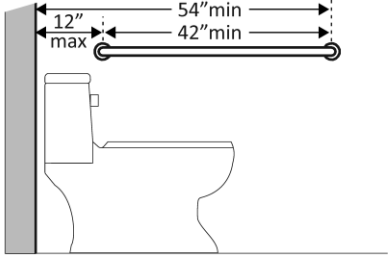
			<p>Photo #:</p>	<p>not swing into the required clearances at fixtures (such as lavatories, water closet and urinals) and the edge of the lavatory is at least 18 inches from the centerline of the water closet</p> <ul style="list-style-type: none"> • Alter room/compartment for clearance • •
<p>3.32 Is the height of the water closet no less than 17 inches and no greater than 19 inches above the floor measured to the top of the seat? [604.4]</p>	<p><input type="checkbox"/> Yes <input type="checkbox"/> No</p> <p>Measurement:</p>		<p>Photo #:</p>	<ul style="list-style-type: none"> • Adjust toilet height • Replace toilet •
<p>3.33 Is there a grab bar at least 42 inches long on the side wall?</p> <p>Is it located no more than 12 inches from the rear wall?</p> <p>Does it extend at least 54 inches from the rear wall? [604.5.1]</p>	<p><input type="checkbox"/> Yes <input type="checkbox"/> No</p> <p>Measurement:</p> <p><input type="checkbox"/> Yes <input type="checkbox"/> No</p> <p>Measurement:</p> <p><input type="checkbox"/> Yes <input type="checkbox"/> No</p> <p>Measurement:</p>		<p>Photo #:</p>	<ul style="list-style-type: none"> • Install grab bar • Relocate grab bar • Relocate objects •

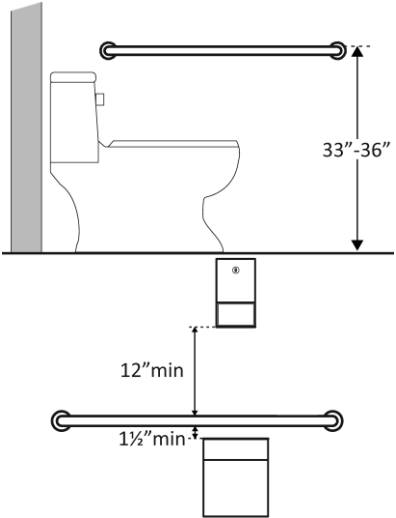
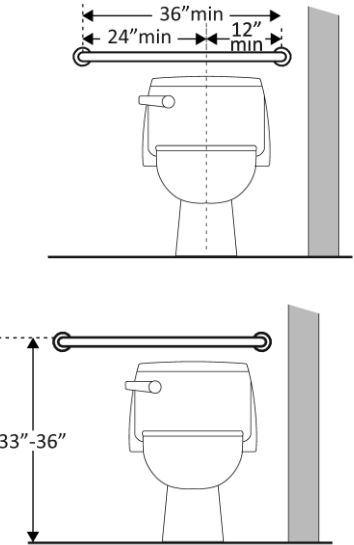
<p>Is it mounted no less than 33 inches and no greater than 36 inches above the floor to the top of the gripping surface? [609.4]</p> <p>Is there at least 12 inches clearance between the grab bar and protruding objects above?*</p> <p>Is there at least 1½ inches clearance between the grab bar and projecting objects below?*</p> <p>Is the space between the wall and the grab bar 1 ½ inches? [609.3]</p>	<p><input type="checkbox"/> Yes <input type="checkbox"/> No Measurement:</p> <p><input type="checkbox"/> Yes <input type="checkbox"/> No Measurement:</p> <p><input type="checkbox"/> Yes <input type="checkbox"/> No Measurement:</p> <p><input type="checkbox"/> Yes <input type="checkbox"/> No Measurement:</p>		<p>Photo #:</p>	<p>* If constructed before 3/15/2012 grab bars do not need to be relocated; there are no space requirements above and below grab bars in the 1991 Standards</p>
<p>3.34 Is there a grab bar at least 36 inches long on the rear wall?</p> <p>Does it extend at least 12 inches from the centerline of the water closet on one side (side wall)?</p> <p>Does it extend at least 24 inches on the other (open) side? [604.5.2]</p> <p>Is it mounted no less than 33 inches and no greater than 36 inches above the floor to the top of the gripping surface?</p>	<p><input type="checkbox"/> Yes <input type="checkbox"/> No Measurement:</p> <p><input type="checkbox"/> Yes <input type="checkbox"/> No Measurement:</p> <p><input type="checkbox"/> Yes <input type="checkbox"/> No Measurement:</p> <p><input type="checkbox"/> Yes <input type="checkbox"/> No Measurement:</p>		<p>Photo #:</p>	<ul style="list-style-type: none"> • Install grab bar • Relocate grab bar • Relocate objects •

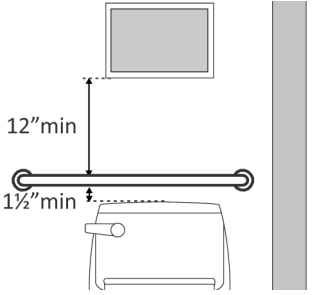
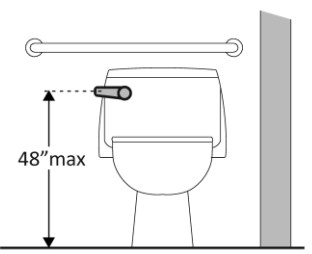
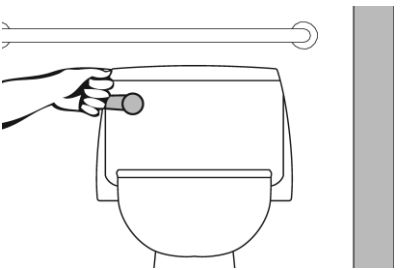
<p>[609.4]</p> <p>Are there at least 12 inches clearance between the grab bar and protruding objects above?*</p> <p>Are there at least 1½ inches clearance between the grab bar and projecting objects below?*</p> <p>Is the space between the wall and the grab bar 1½ inches? [609.3]</p>	<p><input type="checkbox"/> Yes <input type="checkbox"/> No Measurement:</p> <p><input type="checkbox"/> Yes <input type="checkbox"/> No Measurement:</p> <p><input type="checkbox"/> Yes <input type="checkbox"/> No Measurement:</p>		<p>Photo #:</p>	<p>* If constructed before 3/15/2012 grab bars do not need to be relocated; there are no space requirements above and below grab bars in the 1991 Standards</p>
<p>3.35 If the flush control is hand operated, is the operable part located no higher than 48 inches above the floor? [604.6]</p>	<p><input type="checkbox"/> Yes <input type="checkbox"/> No Measurement:</p>		<p>Photo #:</p>	<ul style="list-style-type: none"> • Move control • Install sensor with override button no higher than 48 inches •
<p>3.36 If the flush control is hand operated, can it be operated with one hand and without tight grasping, pinching, or twisting of the wrist?</p> <p>Is the force required to activate the flush control no greater than 5 pounds? [605.4]</p>	<p><input type="checkbox"/> Yes <input type="checkbox"/> No</p> <p><input type="checkbox"/> Yes <input type="checkbox"/> No Measurement:</p>		<p>Photo #:</p>	<ul style="list-style-type: none"> • Change control • Adjust control •

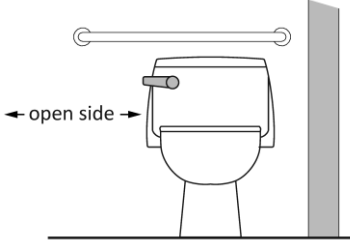
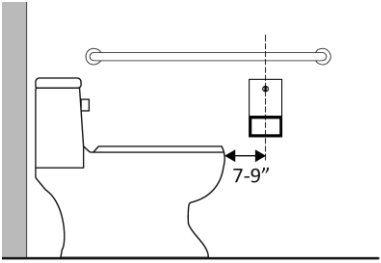
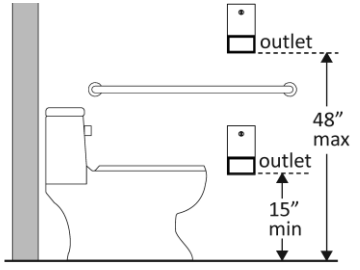
<p>3.37 Is the flush control on the open side of the water closet? [604.6]</p>	<p><input type="checkbox"/> Yes <input type="checkbox"/> No</p>		<p>Photo #:</p>	<ul style="list-style-type: none"> • Move control • •
<p>3.38 Is the toilet paper dispenser located no less than 7 inches and no greater than 9 inches from the front of the water closet to the centerline of the dispenser?*</p> <p>[604.7]</p>	<p><input type="checkbox"/> Yes <input type="checkbox"/> No</p> <p>Measurement:</p>		<p>Photo #:</p>	<p>* If constructed before 3/15/2012 dispenser does not need to be relocated if it is within reach from the water closet seat; the 1991 Standards do not specify distance from the front of the water closet</p> <ul style="list-style-type: none"> • Relocate dispenser • •
<p>3.39 Is the outlet of the dispenser:</p> <p>Located no less than 15 inches and no greater than 48 inches above the floor?</p> <p>Not located behind grab bars?</p> <p>[604.7]</p>	<p><input type="checkbox"/> Yes <input type="checkbox"/> No</p> <p>Measurement:</p> <p><input type="checkbox"/> Yes <input type="checkbox"/> No</p>		<p>Photo #:</p>	<ul style="list-style-type: none"> • Relocate dispenser • •

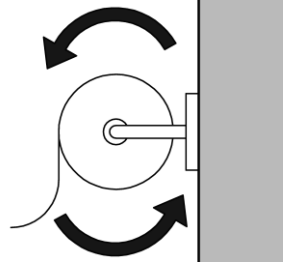
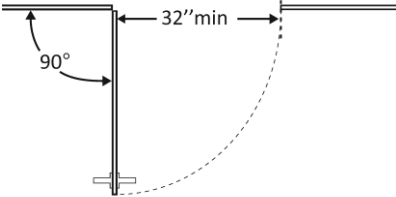
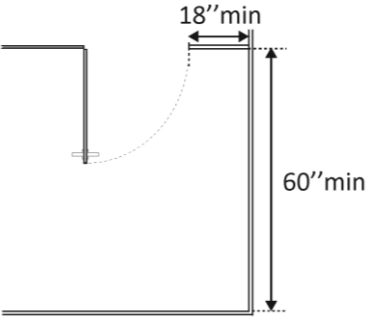
<p>3.40 Does the dispenser allow continuous paper flow? [604.7]</p>	<p><input type="checkbox"/> Yes <input type="checkbox"/> No</p>		<p>Photo #:</p>	<ul style="list-style-type: none"> • Adjust dispenser • Replace dispenser •
<p>Toilet Compartments (Stalls)</p>				
<p>3.41 Is the door opening width at least 32 inches clear, between the face of the door and the stop, when the door is open 90 degrees? [604.8.1.2]</p>	<p><input type="checkbox"/> Yes <input type="checkbox"/> No</p> <p>Measurement:</p>		<p>Photo #:</p>	<ul style="list-style-type: none"> • Widen door width • •
<p>3.42 If there is a front approach to the pull side of the door, is there at least 18 inches of maneuvering clearance beyond the latch side plus 60 inches clear depth? [604.8.1.2]</p> <p>Note: See 2010 Standards 604.8.1.2 Doors for maneuvering clearance requirements on the push side of the door and side approaches to the pull side of the door</p>	<p><input type="checkbox"/> Yes <input type="checkbox"/> No</p> <p>Measurement:</p>		<p>Photo #:</p>	<ul style="list-style-type: none"> • Remove obstructions • •

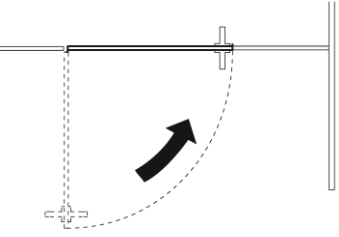
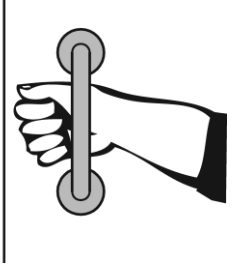
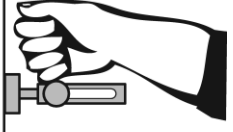
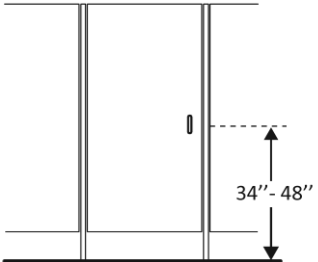
<p>3.43 Is the door self-closing? [604.8.1.2]</p>	<p><input type="checkbox"/> Yes <input type="checkbox"/> No</p>		<p>Photo #:</p>	<ul style="list-style-type: none"> • Add closer • Replace door •
<p>3.44 Are there door pulls on both sides of the door that are operable with one hand and do not require tight grasping pinching or twisting of the wrist?*</p> <p>[604.8.1.2]</p>	<p><input type="checkbox"/> Yes <input type="checkbox"/> No</p>		<p>Photo #:</p>	<p>* If constructed before 3/15/2012 door pulls do not need to be added; door pulls are not required in the 1991 Standards</p> <ul style="list-style-type: none"> • Replace hardware • •
<p>3.45 Is the lock operable with one hand and without tight grasping, pinching or twisting of the wrist?</p> <p>[309.4]</p>	<p><input type="checkbox"/> Yes <input type="checkbox"/> No</p>		<p>Photo #:</p>	<ul style="list-style-type: none"> • Replace lock • •
<p>3.46 Are the operable parts of the door hardware mounted no less than 34 inches and no greater than 48 inches above the floor?</p> <p>[404.2.7]</p>	<p><input type="checkbox"/> Yes <input type="checkbox"/> No</p> <p>Measurement:</p>		<p>Photo #:</p>	<ul style="list-style-type: none"> • Relocate hardware • •

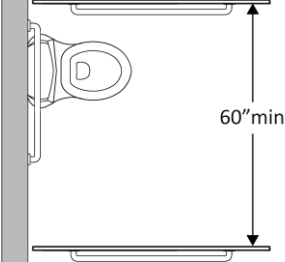
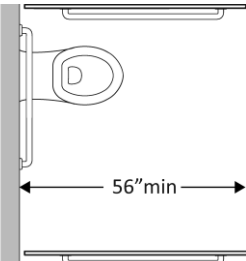
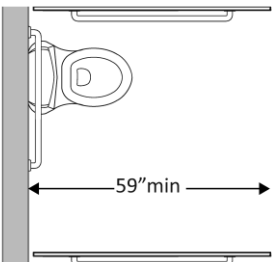
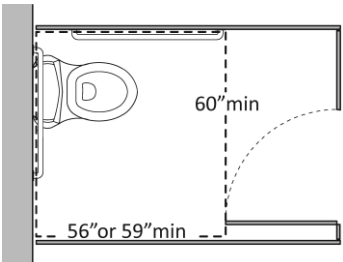
<p>3.47 Is the compartment at least 60 inches wide? [604.8.1.1]</p>	<p><input type="checkbox"/> Yes <input type="checkbox"/> No</p> <p>Measurement:</p>		<p>Photo #:</p>	<ul style="list-style-type: none"> • Widen compartment • •
<p>3.48 If the water closet is wall hung, is the compartment at least 56 inches deep? [604.8.1.1]</p>	<p><input type="checkbox"/> Yes <input type="checkbox"/> No</p> <p>Measurement:</p>		<p>Photo #:</p>	<ul style="list-style-type: none"> • Widen compartment • •
<p>3.49 If the water closet is floor mounted, is the compartment at least 59 inches deep? [604.8.1.1]</p>	<p><input type="checkbox"/> Yes <input type="checkbox"/> No</p> <p>Measurement:</p>		<p>Photo #:</p>	<ul style="list-style-type: none"> • Alter compartment • •
<p>3.50 If the door swings in, is the minimum required compartment area provided beyond the swing of the door (60 inches x 56 inches if water closet is wall hung or 59 inches if water closet is floor mounted)? [604.8.1.1]</p>	<p><input type="checkbox"/> Yes <input type="checkbox"/> No</p> <p>Measurement:</p>		<p>Photo #:</p>	<ul style="list-style-type: none"> • Reverse door swing • Alter compartment •

ADA Checklist for Existing Facilities

Priority 4 – Additional Access

Based on the 2010 ADA Standards for Accessible Design

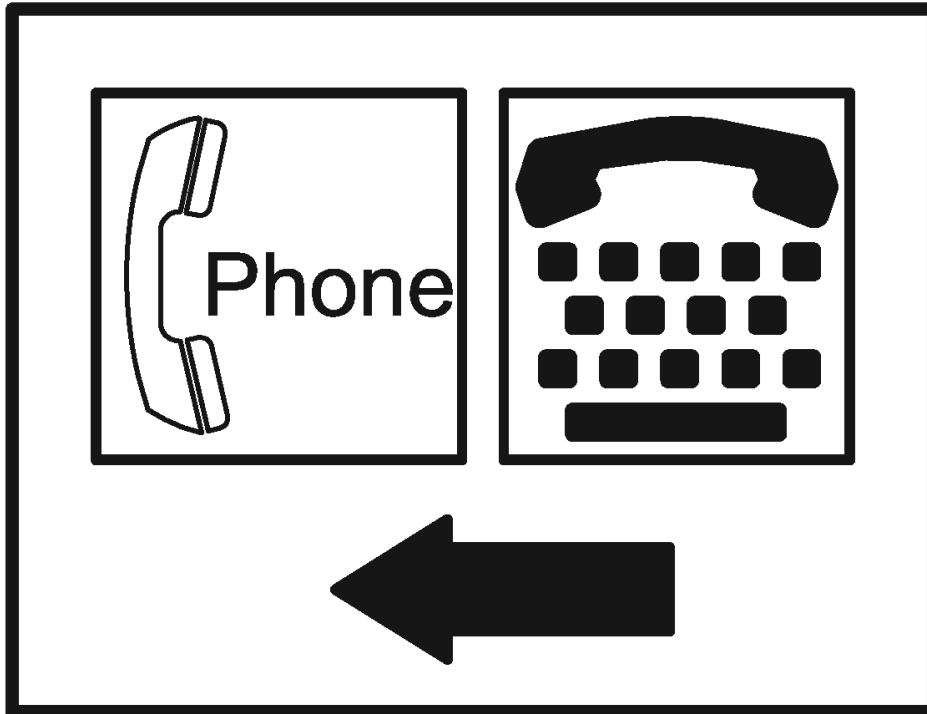

Project _____

Building _____

Location _____

Date _____

Surveyors _____

Contact Information _____

Amenities such as drinking fountains and public telephones should be accessible to people with disabilities.



Institute for Human Centered Design
www.HumanCenteredDesign.org

2014





ADA National Network
Questions on the ADA 800-949-4232 voice/tty
www.ADAchecklist.org

This checklist was produced by the New England ADA Center, a project of the Institute for Human Centered Design and a member of the ADA National Network. This checklist was developed under a grant from the Department of Education, NIDRR grant number H133A060092-09A. However the contents do not necessarily represent the policy of the Department of Education, and you should not assume endorsement by the Federal Government.

Questions or comments on the checklist contact the New England ADA Center at 617-695-0085 voice/tty or ADAinfo@NewEnglandADA.org

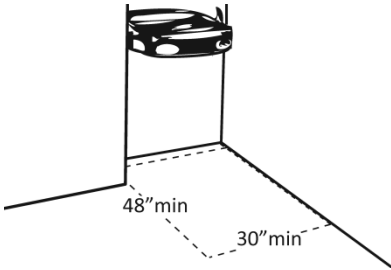
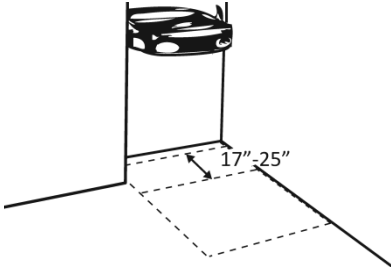

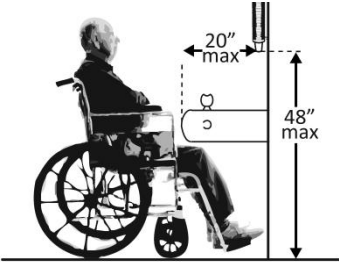
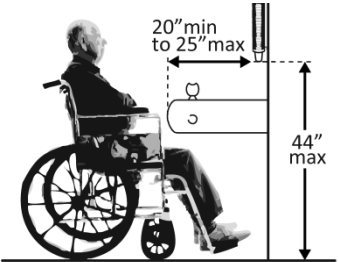

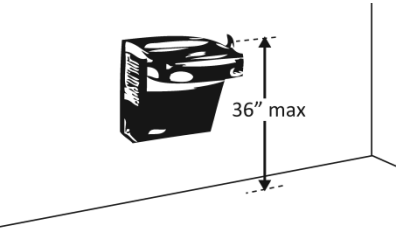
For the full set of checklists, including the checklists for recreation facilities visit www.ADAchecklist.org.

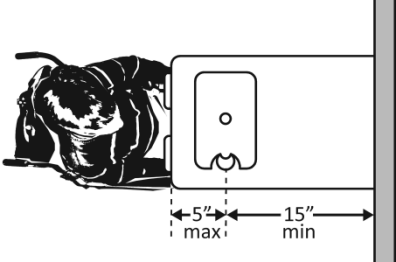
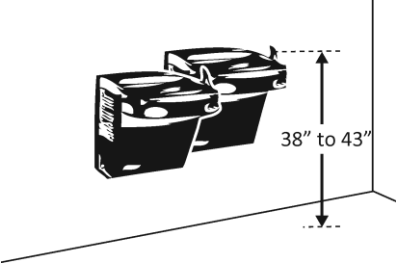
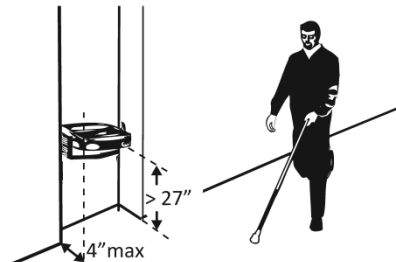

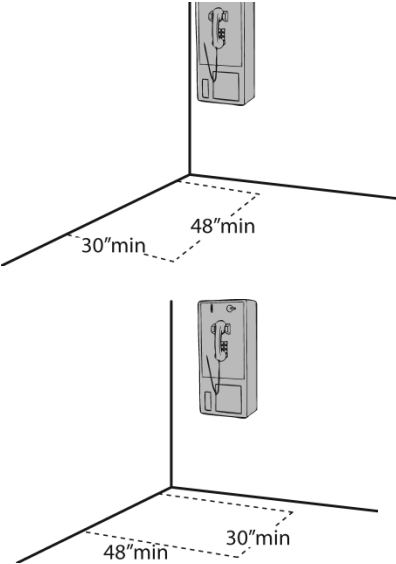
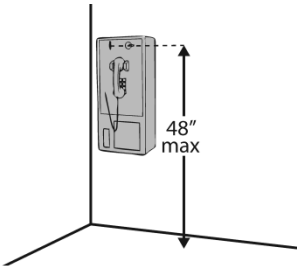
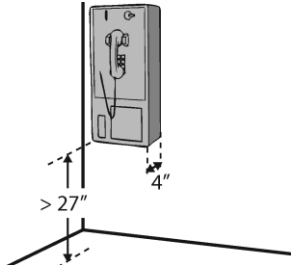
Priority 4 – Additional Access		Comments	Possible Solutions
Drinking Fountains			
<p>4.1 Does at least one drinking fountain have a clear floor space at least 30 inches wide x at least 48 inches long centered in front of it for a forward approach?*</p> <p>[See 2010 ADA Standards for Accessible Design – 602.2]</p>	<p><input type="checkbox"/> Yes <input type="checkbox"/> No</p> <p>Measurement:</p>		<p>Photo #:</p> <p>*If installed before 3/15/2012, a parallel approach is permitted and the clear floor space is not required to be centered</p> <ul style="list-style-type: none"> • Alter space • Relocate drinking fountain • Install a drinking fountain in another location
<p>4.2 If there is a forward approach, do no less than 17 inches and no greater than 25 inches of the clear floor space extend under the drinking fountain?</p> <p>[306.2.2, 306.2.3]</p> <p>Note: If the drinking fountain is primarily for children’s use and the spout is no more than 30 inches above the floor and no more than 3 ½ inches from the edge of the unit, a parallel approach is permitted.</p>	<p><input type="checkbox"/> Yes <input type="checkbox"/> No</p> <p>Measurement:</p>		<p>Photo #:</p> <ul style="list-style-type: none"> • Alter space • Replace drinking fountain •

<p>4.3 If the drinking fountain is no deeper than 20 inches, are the operable parts no higher than 48 inches above the floor? [308.2.2]</p>	<p><input type="checkbox"/> Yes <input type="checkbox"/> No</p> <p>Measurement:</p>		<p>Photo #:</p>	<ul style="list-style-type: none"> • Adjust drinking fountain • Replace drinking fountain •
<p>4.4 If the drinking fountain is no less than 20 inches and no greater than 25 inches deep, are the operable parts no higher than 44 inches above the floor? [308.2.2]</p>	<p><input type="checkbox"/> Yes <input type="checkbox"/> No</p> <p>Measurement:</p>		<p>Photo #:</p>	<ul style="list-style-type: none"> • Adjust drinking fountain • Replace drinking fountain •
<p>4.5 Can the control be operated with one hand and without tight grasping, pinching or twisting of the wrist?</p> <p>Is the force required to activate the control no more than 5 pounds? [309.4]</p>	<p><input type="checkbox"/> Yes <input type="checkbox"/> No</p> <p><input type="checkbox"/> Yes <input type="checkbox"/> No</p> <p>Measurement:</p>		<p>Photo #:</p>	<ul style="list-style-type: none"> • Change control • Adjust control •
<p>4.6 Is the spout outlet no higher than 36 inches above the floor? [602.4]</p>	<p><input type="checkbox"/> Yes <input type="checkbox"/> No</p> <p>Measurement:</p>		<p>Photo #:</p>	<ul style="list-style-type: none"> • Adjust drinking fountain • Replace drinking fountain •

<p>4.7 Is the spout:</p> <p>At least 15 inches from the rear of the drinking fountain?</p> <p><input type="checkbox"/> Yes <input type="checkbox"/> No</p> <p>Measurement:</p> <p>No more than 5 inches from the front of the drinking fountain? [602.5]</p> <p><input type="checkbox"/> Yes <input type="checkbox"/> No</p> <p>Measurement:</p>	<p><input type="checkbox"/> Yes <input type="checkbox"/> No</p> <p>Measurement:</p> <p><input type="checkbox"/> Yes <input type="checkbox"/> No</p> <p>Measurement:</p>		<p>Photo #:</p>	<ul style="list-style-type: none"> • Adjust spout • Replace drinking fountain •
<p>4.8 If there is more than one drinking fountain, is there at least one for standing persons? [211.2]</p> <p>Is the spout outlet no lower than 38 inches and no higher than 43 inches above the floor? [602.7]</p>	<p><input type="checkbox"/> Yes <input type="checkbox"/> No</p> <p><input type="checkbox"/> Yes <input type="checkbox"/> No</p> <p>Measurement:</p>		<p>Photo #:</p>	<ul style="list-style-type: none"> • Adjust drinking fountain • Install new drinking fountain for standing height •
<p>4.9 If the leading (bottom) edge of the fountain is higher than 27 inches above the floor, does the front of the fountain protrude no more than 4 inches into the circulation path? [307.2]</p>	<p><input type="checkbox"/> Yes <input type="checkbox"/> No</p> <p>Measurement:</p>		<p>Photo #:</p>	<ul style="list-style-type: none"> • Adjust drinking fountain • Replace drinking fountain • Add tactile warning such as permanent planter or partial walls

Public Telephones				
<p>4.10 Does at least one telephone have a clear floor space at least 30 inches wide x at least 48 inches long for a parallel or forward approach? [704.2.1]</p>	<p><input type="checkbox"/> Yes <input type="checkbox"/> No</p>		<p>Photo #:</p>	<ul style="list-style-type: none"> • Move telephone • Install new telephone for clear floor space •
<p>4.11 Is the highest operable part of the telephone no higher than 48 inches above the floor? [704.2.2]</p>	<p><input type="checkbox"/> Yes <input type="checkbox"/> No</p> <p>Measurement:</p>		<p>Photo #:</p>	<ul style="list-style-type: none"> • Adjust telephone • •
<p>4.12 If the leading (bottom) edge of the telephone is higher than 27 inches above the floor, does the front of the telephone protrude no more than 4 inches into the circulation path? [307.2]</p>	<p><input type="checkbox"/> Yes <input type="checkbox"/> No</p> <p>Measurement:</p>		<p>Photo #:</p>	<ul style="list-style-type: none"> • Adjust telephone • •

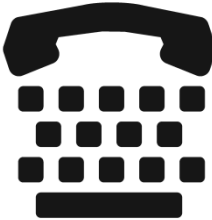
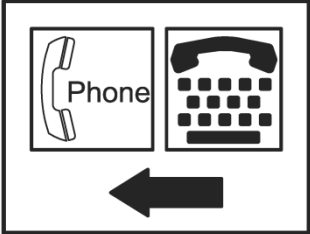
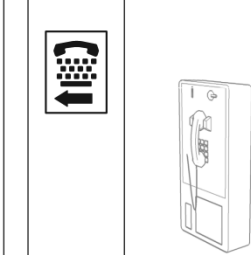
<p>4.13 Does at least one telephone have a volume control? [704.3]</p>	<p><input type="checkbox"/> Yes <input type="checkbox"/> No</p>		<p>Photo #:</p>	<ul style="list-style-type: none"> • Install volume control • Replace telephone with one that has volume control •
<p>4.14 Is the volume control identified by a pictogram of a telephone handset with radiating sound waves? [703.7.2.3]</p>	<p><input type="checkbox"/> Yes <input type="checkbox"/> No</p>		<p>Photo #:</p>	<ul style="list-style-type: none"> • Add pictogram • •
<p>4.15 Does at least one telephone have a TTY? [217.4.1]</p> <p>Note: TTY's are devices that employ interactive text-based communication through the transmission of coded signals across the telephone network. They are mainly used by people who are deaf and/or cannot speak.</p>	<p><input type="checkbox"/> Yes <input type="checkbox"/> No</p>		<p>Photo #:</p>	<ul style="list-style-type: none"> • Install TTY • •
<p>4.16 Is the touch surface of the TTY keypad at least 34 inches above the floor? [704.4.1]</p> <p>Note: If a seat is provided, the TTY is not required to be 34 inches minimum above the floor.</p>	<p><input type="checkbox"/> Yes <input type="checkbox"/> No</p> <p>Measurement:</p>		<p>Photo #:</p>	<ul style="list-style-type: none"> • Adjust height of TTY • •

<p>4.17 Is the TTY identified by the International Symbol of TTY? [703.7.2.2]</p>	<p><input type="checkbox"/> Yes <input type="checkbox"/> No</p>		<p>Photo #:</p>	<ul style="list-style-type: none"> • Add symbol • •
<p>4.18 Do signs that provide direction to public telephones also provide direction to the TTY? [216.9.2]</p>	<p><input type="checkbox"/> Yes <input type="checkbox"/> No</p>		<p>Photo #:</p>	<ul style="list-style-type: none"> • Add signs • •
<p>4.19 Do telephones that do not have a TTY provide direction to the TTY? [216.9.2]</p>	<p><input type="checkbox"/> Yes <input type="checkbox"/> No</p>		<p>Photo #:</p>	<ul style="list-style-type: none"> • Add signs • •
<p>Fire Alarm Systems</p>				
<p>4.20 If there are fire alarm systems, do they have both flashing lights and audible signals? [702.1]</p>	<p><input type="checkbox"/> Yes <input type="checkbox"/> No</p>		<p>Photo #:</p>	<ul style="list-style-type: none"> • Install audible and visual alarms • •